



At Canolight, we pride ourselves on delivering high-quality, energy-efficient lighting solutions and services. With extensive experience in the lighting industry and a team of skilled professionals, we have successfully provided top-tier lighting equipment for a diverse array of applications, including residential, commercial, industrial, hospitality, retail, resorts, restaurants, cafes, facades, and outdoor spaces. Our products comply with all relevant approvals, safety standards, and certifications in both Canada and the United States.

In addition to premium lighting equipment, we offer professional lighting design services. Our expert team employs advanced design software to calculate and simulate lighting for both interior and exterior spaces, ensuring optimal solutions. We also provide 3D lighting design and simulation services, enabling customers to visualize their lighting setup and make adjustments prior to installation. This process guarantees complete customer satisfaction with the final outcome.

At Canolight, our goal is to exceed your lighting expectations. We believe that Canadian brightness is more than just illumination; it's about living sustainably and preserving our planet for future generations

LED Exterior Lights	1
LED Downlights	29
LED Step Lights	65
LED Vanity Lights	68
LED Strip Lights	71
LED Wall Washer Lights	93
High Voltage LED Strip Lights	96
Aluminum Profiles	99
LED Sheets	105
LED Track Lights	109
LED Linear Lights	117
Controllers	120
LED Power supplies	123
Industrial Lights	131



Exterior Lights

Surface-Mount LED Wall Light



Product Code	Input Voltage	Power	Lumen	Color Temp	Beam angle
CL-WL-2542-10W-3K	110-220VAC, 50Hz	10 W	883lm	3000K	30 ~ 130°

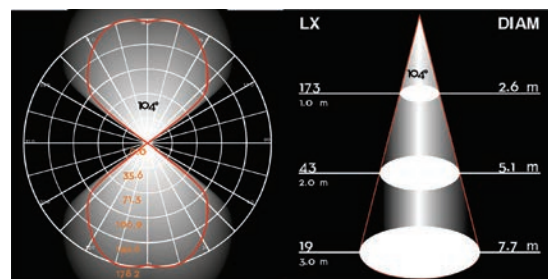
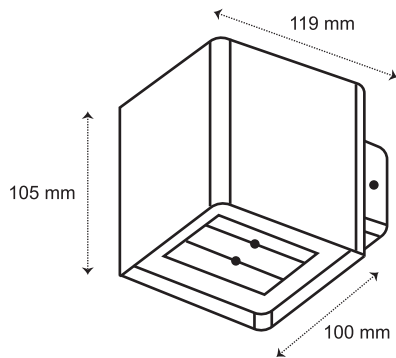

- Pretreated powder coating for outdoor use
- CREE LED chip
- Silicone rubber gasket
- cETL approved

Surface-Mount LED Wall Light



Product Code	Input Voltage	Power	Lumen	Color Temp	Beam angle
CL-WL-1521-15W-3K	110-220VAC, 50Hz	15 W	1200lm	3000K	100°

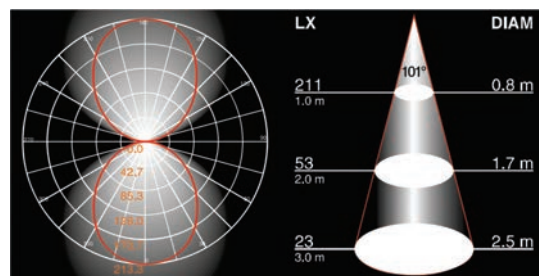
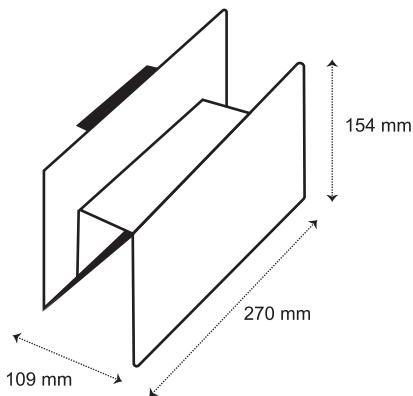

- Pretreated powder coating for outdoor use
- PHILIPS LED chip
- Silicone rubber gasket
- cETL approved
- Designed by Franco Pagliarini

Surface-Mount LED Wall Light



Product Code	Input Voltage	Power	Lumen	Color Temp	Beam angle
CL-WL-2442A-4W-3K	110-220VAC, 50Hz	4 W	321lm	3000K	11°

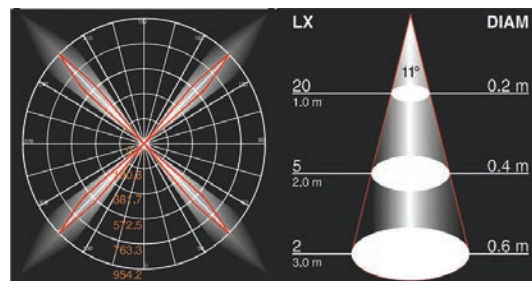
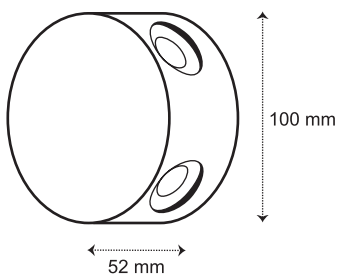

- Pretreated powder coating for outdoor use
- CREE LED chip
- Silicone rubber gasket
- cETL approved

Surface-Mount LED Wall Lights



CL-WL-1141-7W-3K

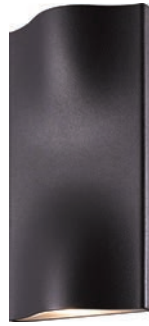

CL-WL-1142-14W-3K



CL-WL-1143-15W-3K

Product Code	Input Voltage	Power	Lumen	Color Temp	Beam angle
CL-WL-1141-7W-3K	110-220VAC, 50Hz	7 W	377 lm	3000K	98°
CL-WL-1142-14W-3K	110-220VAC, 50Hz	14 W	990 lm	3000K	98°
CL-WL-1143-15W-3K	110-220VAC, 50Hz	15 W	752 lm	3000K	97°

Available in White and Black body color

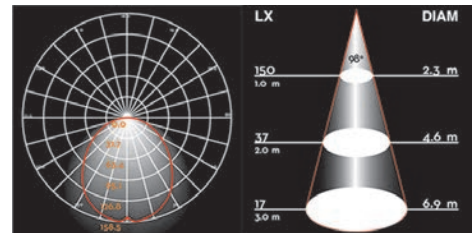
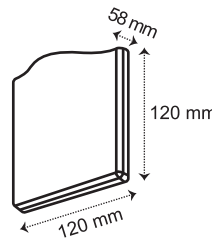

CL-WL-1141

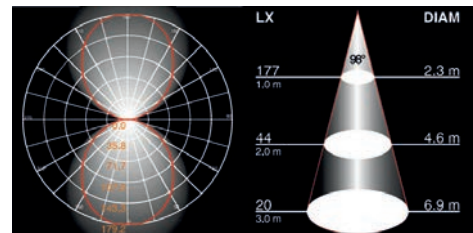
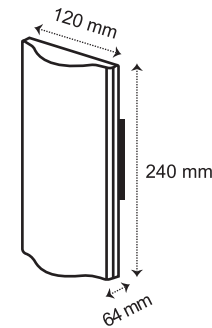

CL-WL-1142

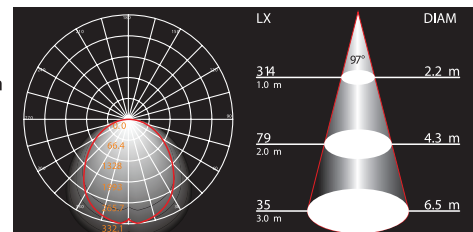
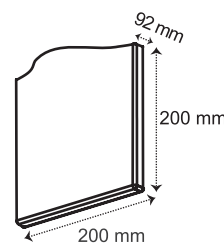

CL-WL-1143

- Pretreated powder coating for outdoor use
- CREE LED chip
- Silicone rubber gasket
- cETL approved
- Designed by Franco Pagliarini



Surface-Mount LED Wall Light



Product Code	Input Voltage	Power	Lumen	Color Temp	Beam angle
CL-WL-2553-8W-3K	110-220VAC, 50Hz	8 W	160lm	3000K	15°/78°

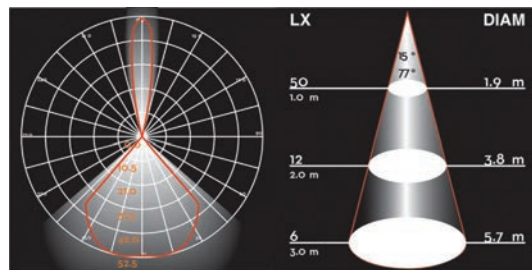
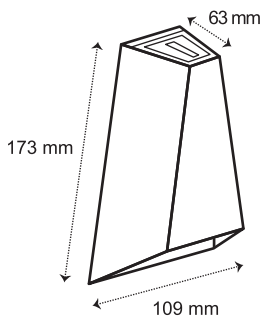

- Pretreated powder coating for outdoor use
- CREE LED chip
- Silicone rubber gasket
- cETL approved

Surface-Mount LED Ceiling Light

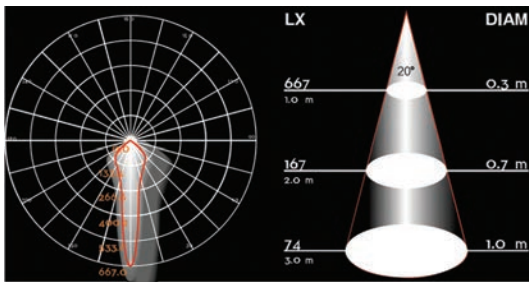
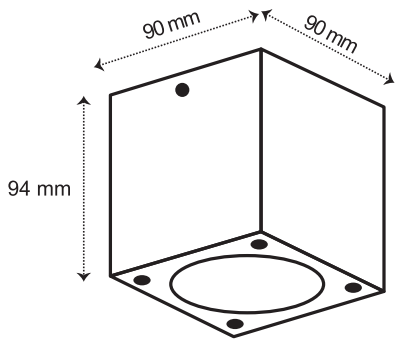

Product Code	Input Voltage	Power	Lumen	Color Temp	Beam angle
CL-SCL-2386-7W-3K	110-240VAC, 50/60Hz	7 W	575 lm	3000K	20°



- Pretreated powder coating for outdoor use
- OSRAM LED chip
- cETL approved

Surface-Mount LED Wall Light



Product Code	Input Voltage	Power	Lumen	Color Temp	Beam angle
CL-WL-18208-11W-3K-WH	110-240VAC ,50/60Hz	11W	740lm	3000K	120°
CL-WL-18208-11W-3K-BL					

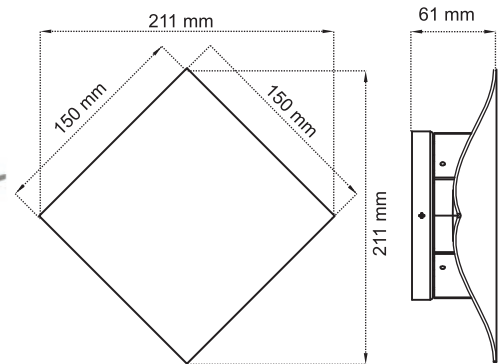

- Pretreated powder coating for outdoor use
- OSRAM LED chip
- cETL approved

Surface-Mount LED Wall Light



Product Code	Input Voltage	Power	Lumen	Color Temp	Beam angle
CL-WL-18209-11W-3K-WH	110-240VAC, 50/60Hz	11W	710lm	3000K	110°
CL-WL-18209-11W-3K-BL					

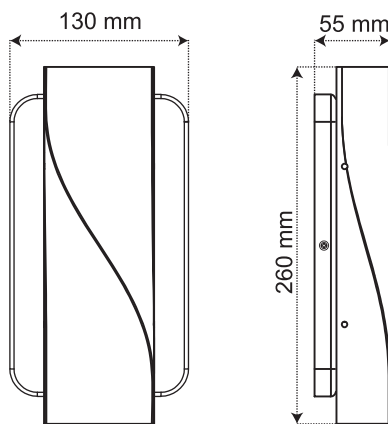

- Pretreated powder coating for outdoor use
- OSRAM LED chip
- cETL approved

Surface-Mount LED Wall Light

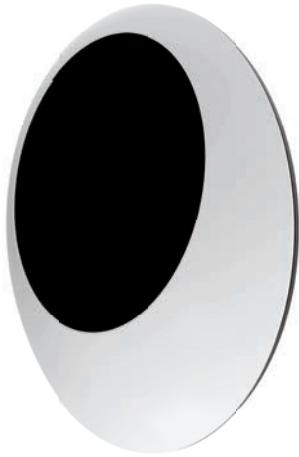

Product Code	Input Voltage	Power	Lumen	Color Temp	Beam angle
CL-WL-16106-13W-3K-BL	110-240VAC, 50/60Hz	13W	960lm	3000K	128°

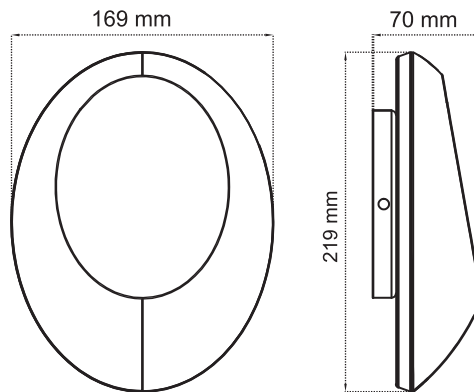

-
-
-
-
-
-
-

- Pretreated powder coating for outdoor use
- OSRAM LED chip
- cETL approved

Surface-Mount LED Wall Light (All in one)

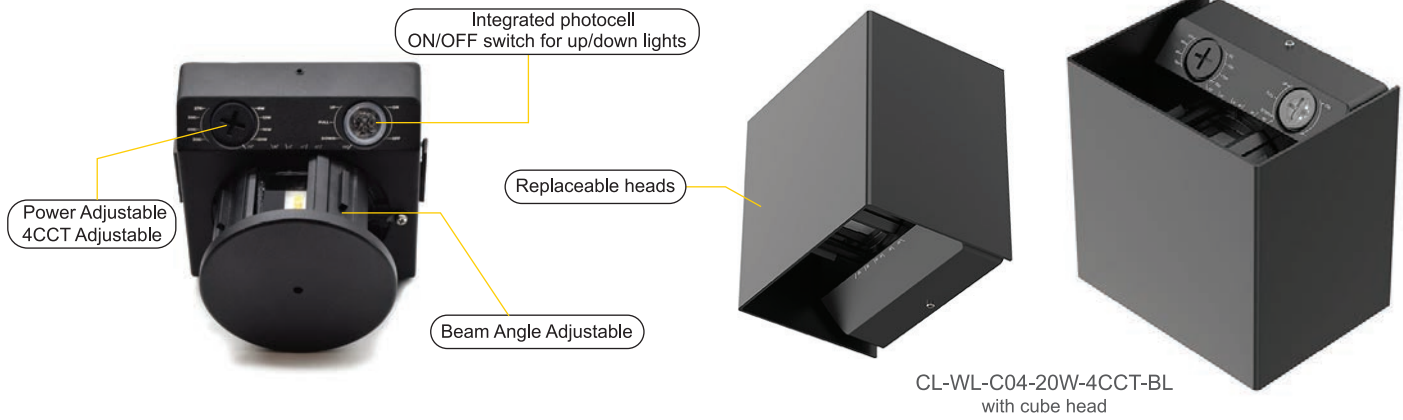

Product Code	Input Voltage	Power	Lumen	Color Temp	Beam angle
CL-WL-C04-20W-4CCT-BL Cube head included	120-347 VAC 50/60Hz	Adjustable 8W/12W/16W/20W	90lm/W	4CCT 2700K-3000K-4000K-5000K	20°-100°

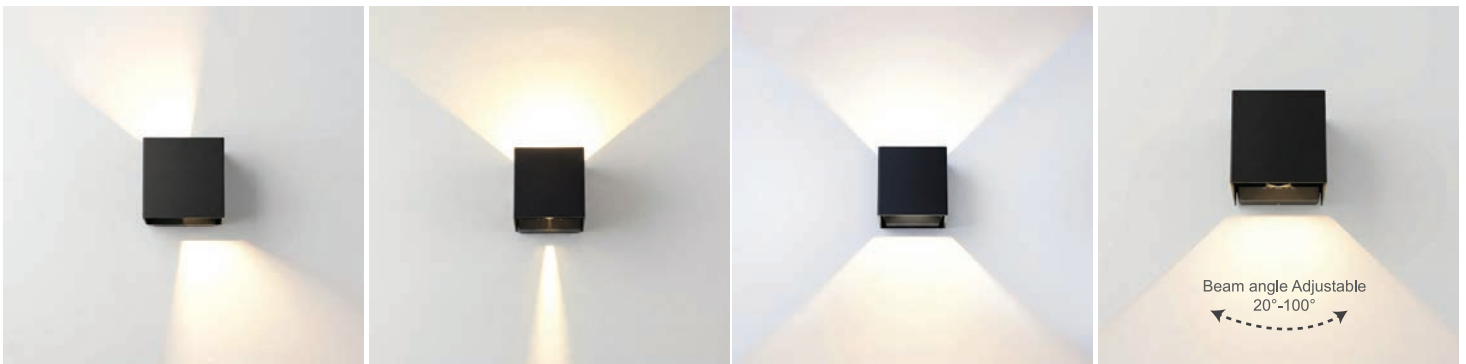
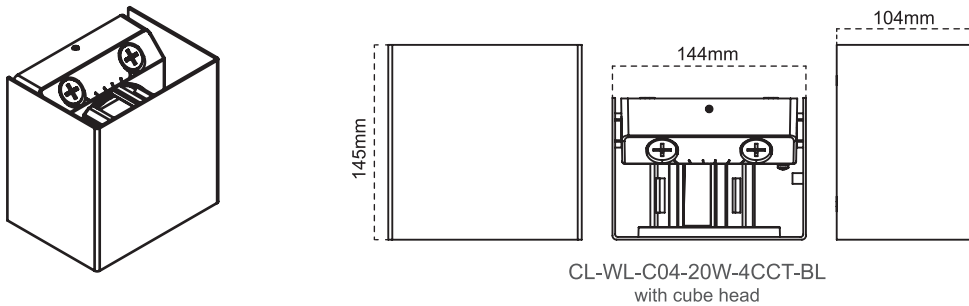

Note: CL-WL-C04-20W-4CCT is supplied with a standard cube head, with optional Arc and Cloud head designs available. Heads are easily interchangeable via a slide-in design.



• cETL approved

Surface-Mount LED Wall Light (All in one)



CL-WL-C04-20W-4CCT-BL
Arc head installed

Note: Optional Arc and Cloud heads available, easily interchangeable via a slide-in design.

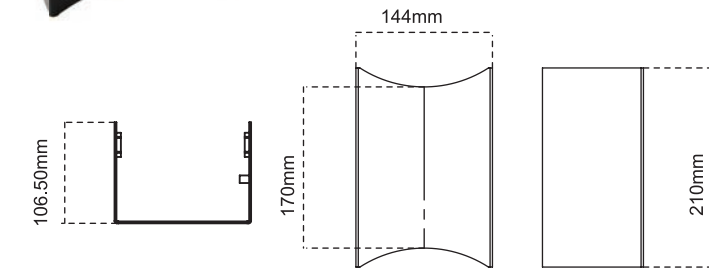

CL-WL-C04-Arc Head-BL
Arc Head



CL-WL-C04-Cloud Head-BL
Cloud Head

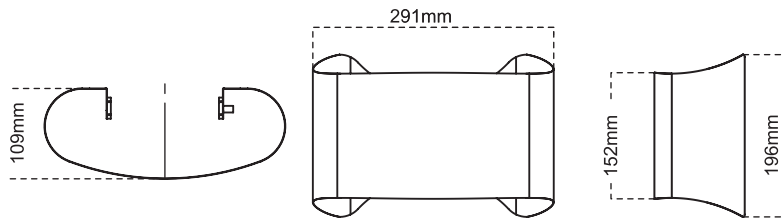

-
-
-
-
-
-
-
-

• cETL approved



CL-WL-C04-20W-4CCT-BL
Cloud head installed

Low Voltage Surface-Mount LED Wall Light



Product Code	Input Voltage	Power	Lumen	Color Temp	Beam angle
CL-WL-LV6090-6W-3K-BL				3000K	
CL-WL-LV6090-6W-4K-BL	9-24V AC/DC	2 x 3W	255lm	4000K	Adjustable 0°~100°
CL-WL-LV6090-6W-5K-BL				5000K	

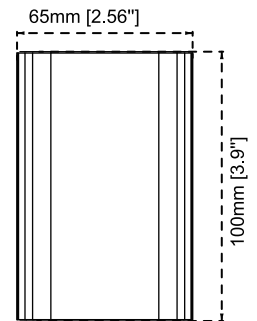
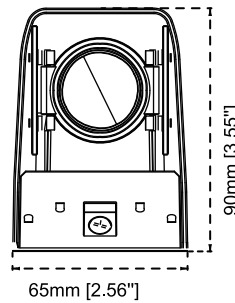
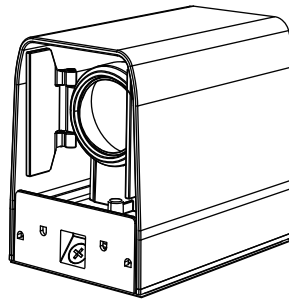

- Separate electrical connections for uplight and downlight control.
- cETL approved

Linear Wall Light



Product Code	Input Voltage	Power	Lumen	Color Temp	IP
CL-WL-L318-12W-3CCT-BL	120-277 VAC	12W	700lm	3CCT	54
CL-WL-L324-16W-3CCT-BL	50/60Hz	16W	1100lm	3000K-4000K-5000K	

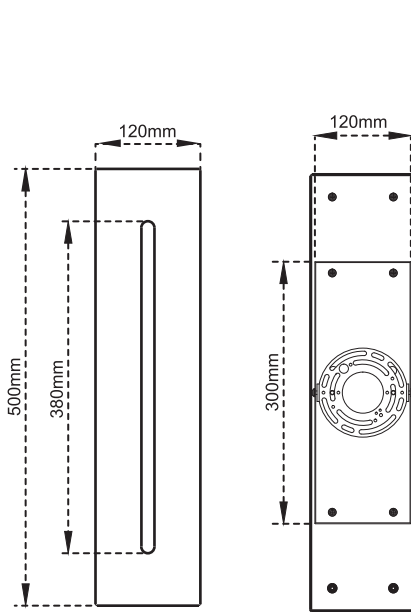

CL-WL-L318-12W-3CCT-BL

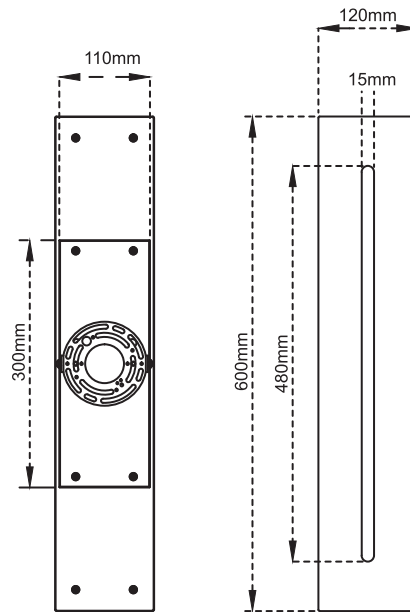

CL-WL-L324-16W-3CCT-BL

• cETL approved

Linear Wall Light

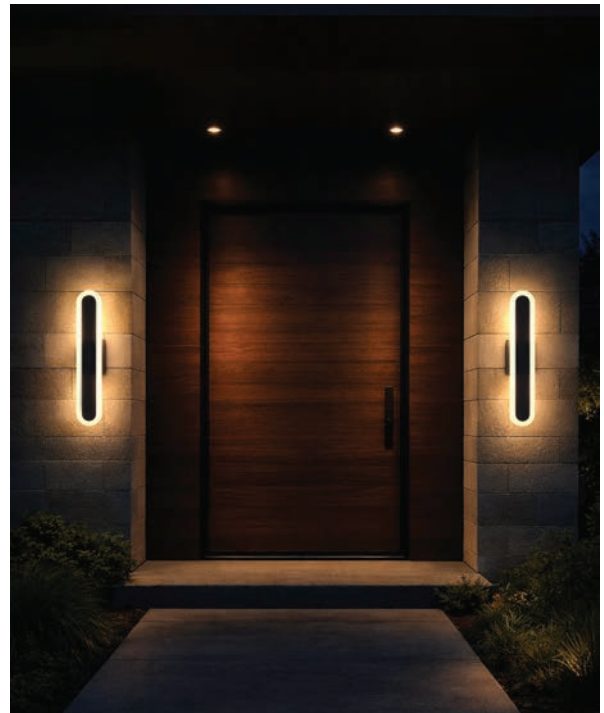

Product Code	Input Voltage	Power	Lumen	Color Temp	IP
CL-WL-L418-12W-3CCT-BL	120-277 VAC	12W	700lm	3CCT	54
CL-WL-L424-16W-3CCT-BL	50/60Hz	16W	1100lm	3000K-4000K-5000K	

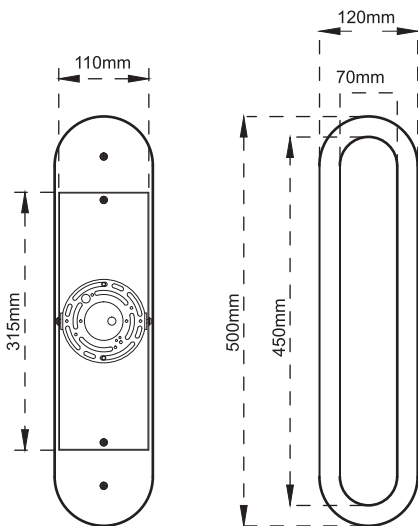

CL-WL-L418-12W-3CCT-BL

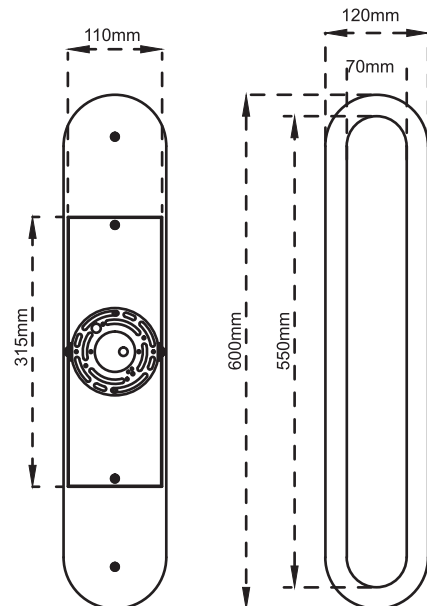

CL-WL-L424-16W-3CCT-BL

• cETL approved

Linear Wall Light



Product Code	Input Voltage	Power	Lumen	Color Temp	IP
CL-WL-L524-18W-3CCT-BL	120-277 VAC	18W	1200lm	3CCT	54
CL-WL-L548-30W-3CCT-BL	50/60Hz	30W	2000lm	3000K-4000K-5000K	

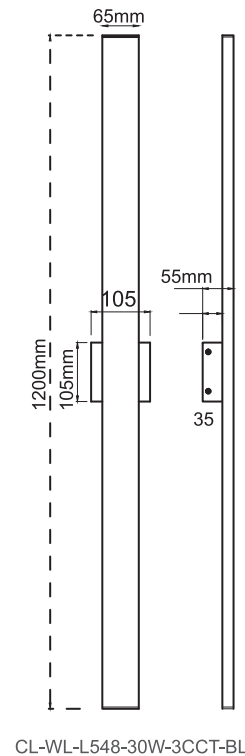
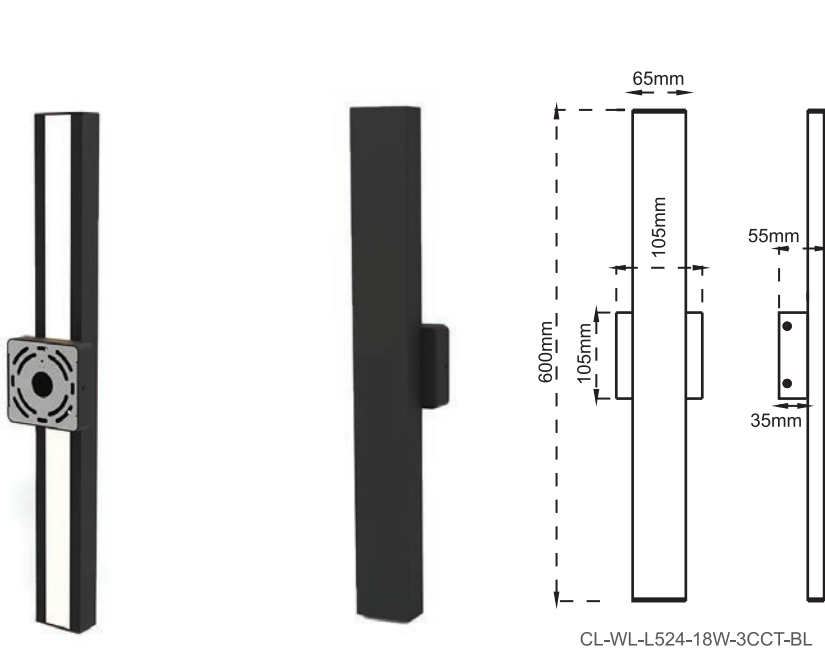

• cETL approved



LED Exterior Lights

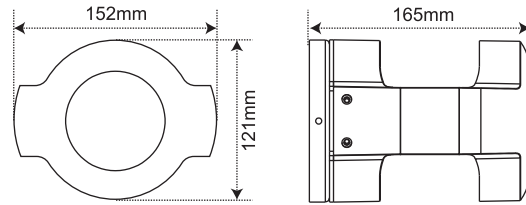

CL-WL-16404-13W-3K-BL

Product Code	Input Voltage	Power	Lumen	Color Temp	Beam angle
CL-WL-16404-13W-3K-BL	110-240VAC	13W	500lm	3000K	330°
CL-GL-16402-12W-3K-BL	12-24VAC/DC	12W	900lm	3000K	247°

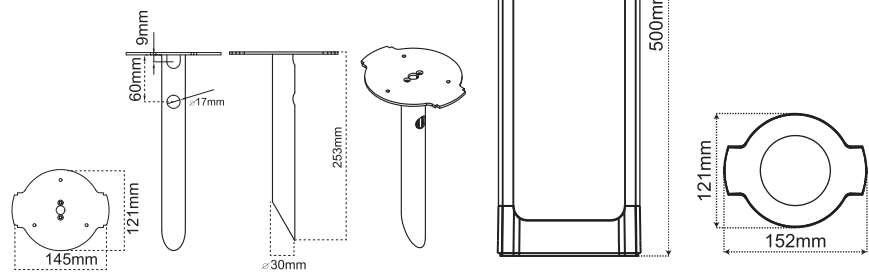

CL-GL-16402-12W-3K-BL

Spike



- Pretreated powder-coated for outdoor use
- OSRAM LED chip
- cETL approved

LED Exterior Lights



Product Code	Input Voltage	Power	Lumen	Color Temp	Beam angle
CL-WL-16604-13W-3K	110-240VAC, 50/60Hz	13W	515lm	3000K	335°

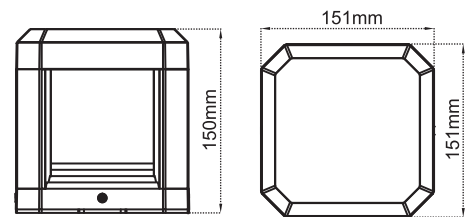

CL-WL-16604-13W-3K

- Pretreated powder coating for outdoor use
- OSRAM LED chip
- cETL approved

LED Exterior Lights



Product Code	Input Voltage	Power	Lumen	Color Temp	Beam angle
CL-GL-16603-12W-3K	12-24VAC/DC	12W	988lm	3000K	236°

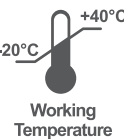
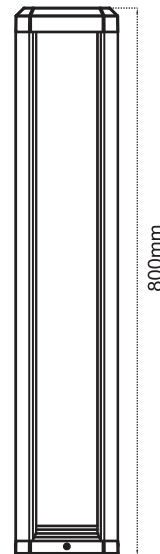
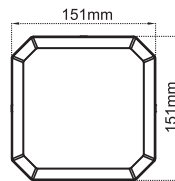
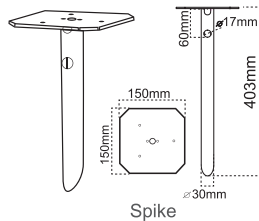

- Pretreated powder coating for outdoor use
- OSRAM LED chip
- cETL approved

LED Exterior Lights

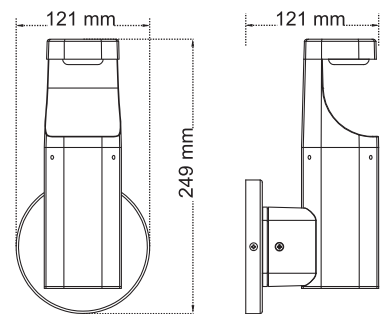

Product Code	Input Voltage	Power	Lumen	Color Temp	Beam angle
CL-WL-14408-7W-3K-BL	110-240VAC, 50/60Hz	7W	290lm	3000K	114°

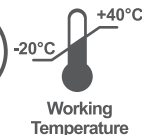

- Pretreated powder coating for outdoor use
- OSRAM LED chip
- cETL approved

LED Exterior Lights

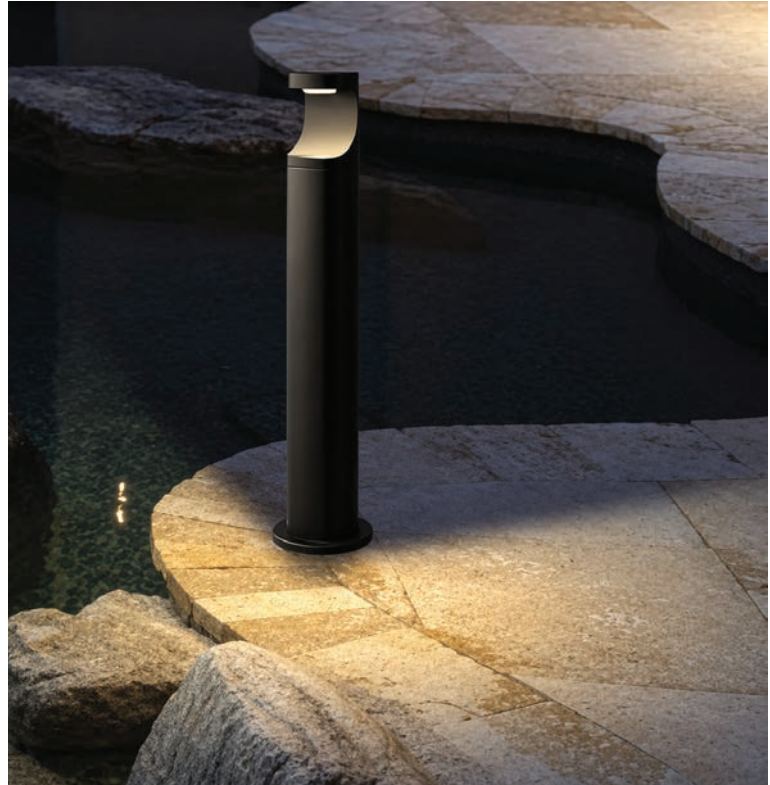

Product Code	Input Voltage	Power	Lumen	Color Temp	Beam angle
CL-GL-14406-7W-3K-BL	12-24VAC/DC	7W	338lm	3000K	189°

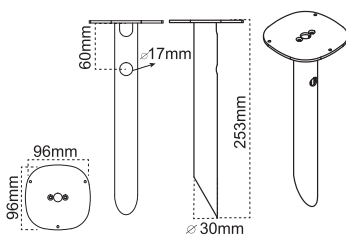

Spike

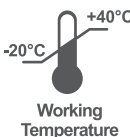
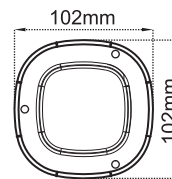

- Pretreated powder coating for outdoor use
- OSRAM LED chip
- cETL approved

LED Garden Lights



Product Code	Input Voltage	Power	Lumen	Color Temp	IP
CL-GL065-524-3CCT-BL	12-24VAC/DC	5 W	200lm	3CCT Adjustable 3000K,4000K,5000K	65

Available Heads

CL-GL065-HEAD A-BL

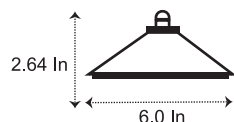

CL-GL065-HEAD B-BL

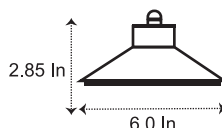

CL-GL065-HEAD C-BL

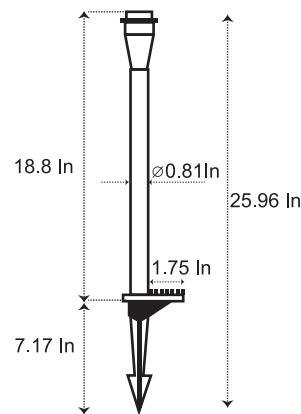
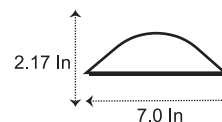

CL-GL065-524-3CCT-BL

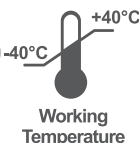

- Epoxy powder paint finish

LED Garden Light



Product Code	Input Voltage	Power	Lumen	Color Temp	IP
CL-GL045-524-3CCT-BL	12-24VAC/DC	5 W	220lm	3CCT Adjustable 3000K,4000K,5000K	65

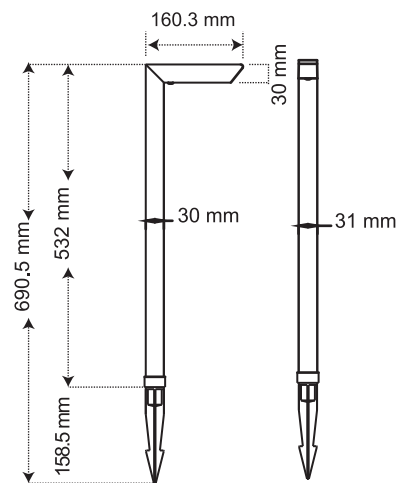

-
-
-
-
-
-
-

• Epoxy powder paint finish

Landscape Spot Lights



Product Code	Input Voltage	Power	Lumen	Beam Angle	Color Temp	IP
CL-LS13-30-724-5CCT-BL	12-24VAC	7W	650lm	30°	5CCT 2700K-3000K-3500K 4000K-5000K	65
CL-LS13-30-524-RGBCW-M-BL	12-24VAC	5W		30°	RGBCW Manual button	65
CL-LS13-30-724-RGBCW-BL	12-24VAC	7 W		30°	RGBCW	65

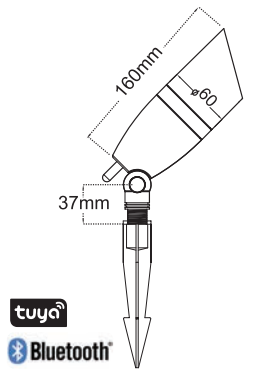

CL-LS13-30-724-RGBCW-BL

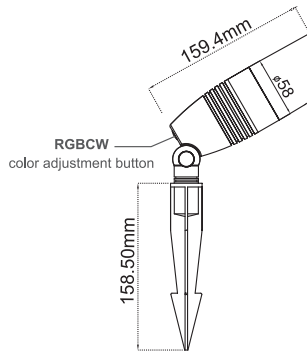

CL-LS13-30-524-RGBCW-M-BL

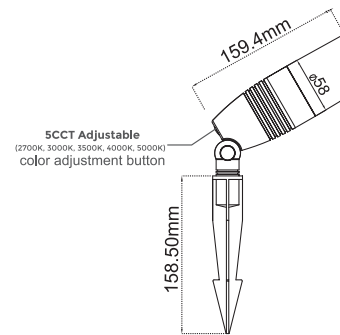

CL-LS13-30-724-5CCT-BL

Installation Accessories

CL-LSA-M03



CL-LSA-M04



CL-LSA-M05



Bluetooth Gateway Available: **CBSMHUB-Signal Repeater**

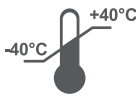

- 180° Adjustable light head
- Tempered glass lens

LED In-ground Light



Product Code	Input Voltage	Power	Lumen	Color Temp	Beam Angle	IP
CL-IG066-624-3K-BL	12-24VAC	6 W	220 lm	3000K	120°	66

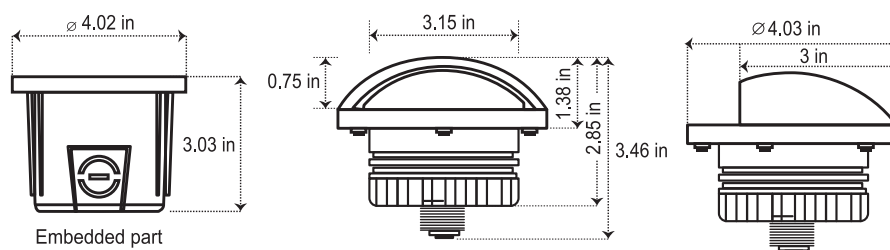

- Die-cast aluminum
- Pretreated powder coating for outdoor use

LED In-ground Lights



CL-IG024-124-SS



CL-IG048-324-SS

Product Code	Input Voltage	Power	Lumen	Color Temp	Beam Angle	IP
CL-IG024-124-3K-SS	12-24VAC	1W	80lm	3000K	30°	67
CL-IG024-124-5K-SS	12-24VAC	1W	80lm	5000K	30°	67
CL-IG048-324-3K-SS	12-24VDC/9-17VAC	3W	250lm	3000K	30°	67
CL-IG048-324-5K-SS	12-24VDC/9-17VAC	3W	250lm	5000K	30°	67

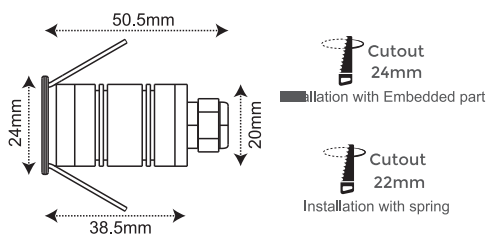

CL-IG024-124-SS

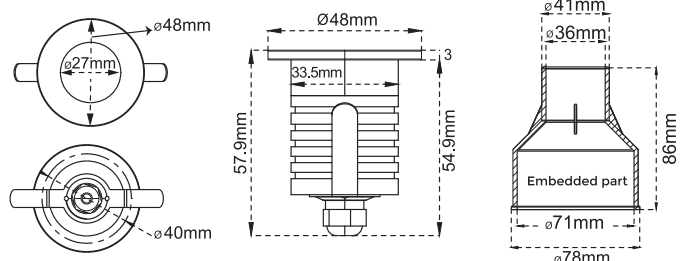

CL-IG048-324-SS

- CL-IG024-124: Stainless steel body
- CL-IG048-324: Stainless steel 304 body with ABS embedded enclosure
- Pretreated powder coating for outdoor use

LED Deck Lights



CL-DL025-524



CL-DL013-324



CL-DL062-324

Product Code	Input Voltage	Power	Lumen	Color Temp	Beam angle
CL-DL025-524-3K-BL	12-24VAC	5 W	300 lm	3000K	120°
CL-DL025-524-5K-BL	12-24VAC	5 W	300 lm	5000K	120°
CL-DL013-324-3K-BL	12-24VAC	3.5 W	110 lm	3000K	55°
CL-DL062-324-3CCT-BL	12-24VAC	3 W	120 lm	3CCT (3000K-4000K-5000K)	55°

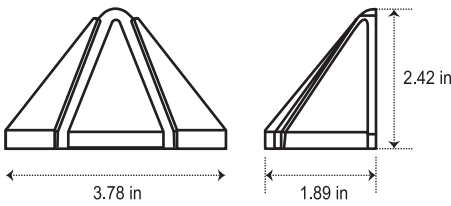

CL-DL025-524

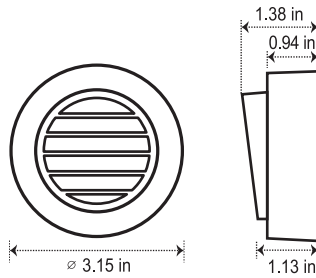

CL-DL013-324

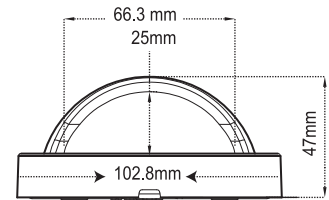

CL-DL062-324



-
-
-
-
-
-
-

- Epoxy powder paint finish

LED Hardscape Lights



7 inch Smart LED Hardscape Light
CL-HS055-524-RGBCW-ORB

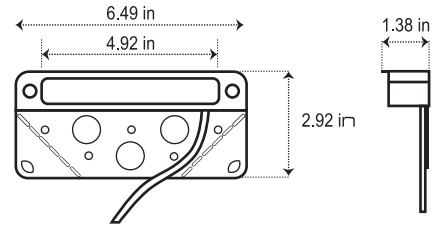

7 inch Replaceable Light Head LED Hardscape
CL-HS045R-324-RGBCW-ORB

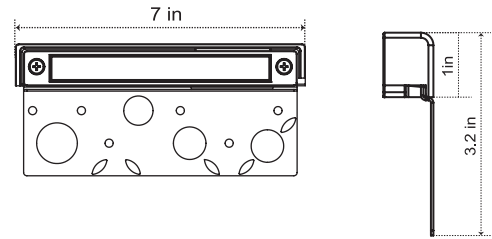

7 inch LED Hardscape Light
CL-HS045-524-3CCT-ORB

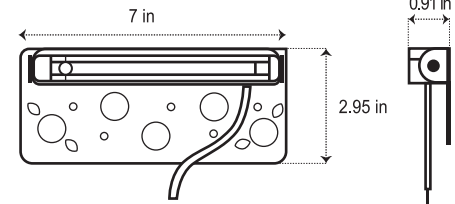

12 inch LED Hardscape Light
CL-HS047-724-3CCT-ORB

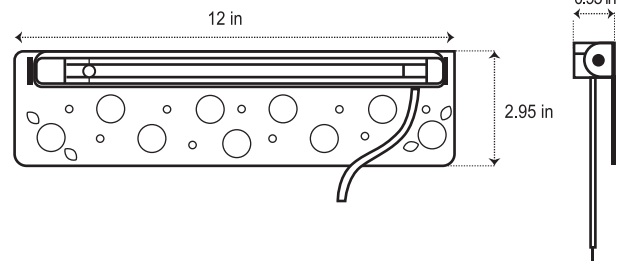

Product Code	Input Voltage	Power	Lumen	Color Temp	Length
CL-HS055-524-RGBCW-ORB	12-24VAC	5 W		RGBCW Applicable with Tuya app	7 inch
CL-HS045R-324-RGBCW-ORB	7-17VAC & 12-24VDC	3W		RGBCW Manual Button	7 inch
CL-HS045-524-3CCT-ORB	12-24VAC	5 W	200 lm	3CCT Adjustable 3000K 4000K 5000K	7 inch
CL-HS047-724-3CCT-ORB	12-24VAC	7 W	280 lm		12 inch

- Epoxy powder paint finishing
- Stainless steel bracket





LED Downlights

cano light
Canadian Brightness

Surface-Mount LED Ceiling Lights

Interchangeable Frames



Product Code	Input Voltage	Power	Lumen	Color Temp
CL-SC1-918-5CCT-WH	120VAC 50/60Hz	18W	1500lm	5CCT Adjustable 2700K-3000K-3500K-4000K-5000K
CL-SC1-1224-5CCT-WH		24W	2000lm	
CL-SC1-1630-5CCT-WH		30W	3000lm	

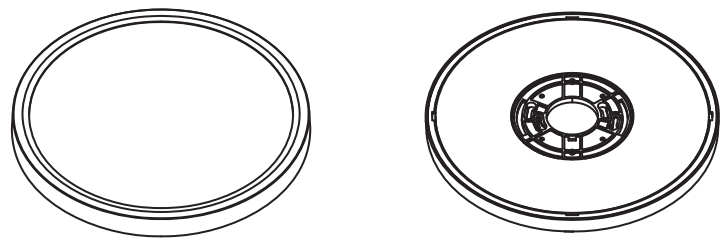
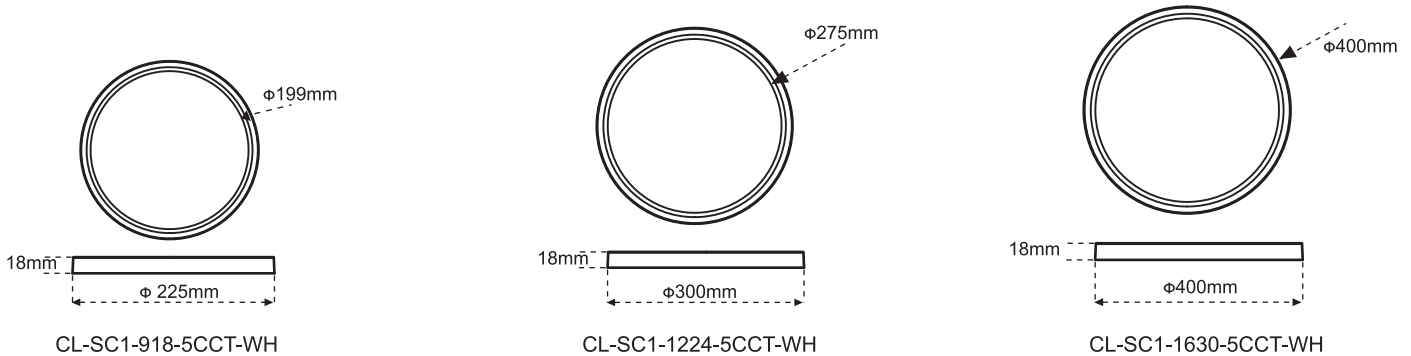

- cETL listed
- CL-SC1-918-5CCT-WH Energy Star

Surface-mount LED Ceiling Lights Accessories



Black and Gold Frame



White and Gold Frame

Frames

CL-SC1-918F-BLGL

CL-SC1-918F-WHGL

Compatible with CL-SC1-918-5CCT-WH

CL-SC1-1224F-BLGL

CL-SC1-1224F-WH-GL

Compatible with CL-SC1-1224-5CCT-WH

CL-SC1-1630F-BLGL

CL-SC1-1630F-WH-GL

Compatible with CL-SC1-1630-5CCT-WH

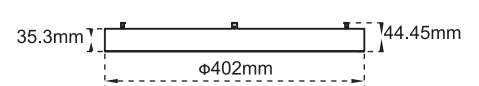
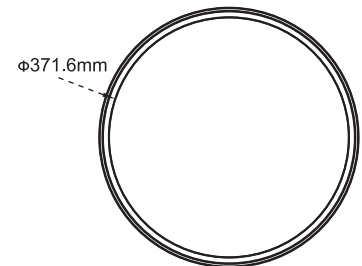
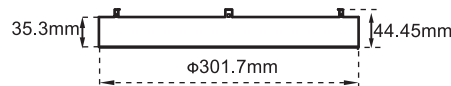
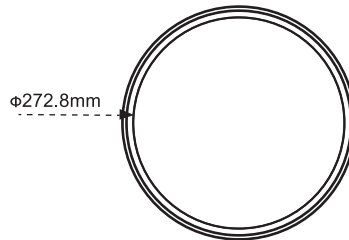
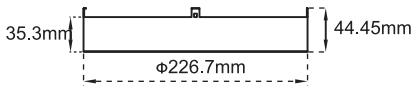
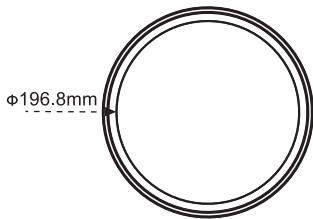

Satin Nickel Ring



Black Ring

Rings

CL-SC1-918R-SN

CL-SC1-918R-BL

Compatible with CL-SC1-918-5CCT-WH

CL-SC1-1224R-SN

CL-SC1-1224R-BL

Compatible with CL-SC1-1224-5CCT-WH

CL-SC1-1630R-SN

CL-SC1-1630R-BL

Compatible with CL-SC1-1630-5CCT-WH

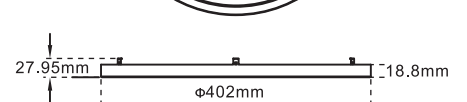
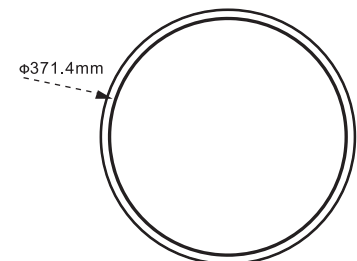
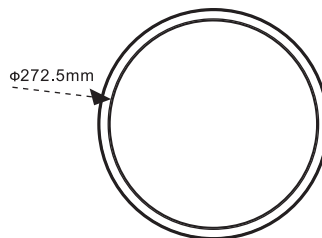
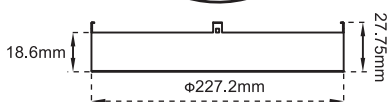
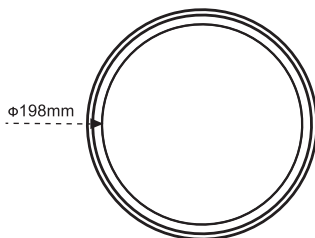

Surface-mount Rotatable LED Downlights



Product Code	Input Voltage	Power	Lumen	Beam Angle	Color Temp	Body Color
CL-DL4-RS-24W-36D-3CCT-WH	120-277 VAC	24W	2160lm	36°	3 CCT	White
CL-DL4-RS-24W-36D-3CCT-BL	120-277 VAC	24W	2160lm	36°	<u>Adjustable</u>	Black
CL-DL4-RS-35W-24D-3CCT-WH	120-277 VAC	35W	3150lm	24°	3000K 4000K	White
CL-DL4-RS-35W-24D-3CCT-BL	120-277 VAC	35W	3150lm	24°	5000K	Black

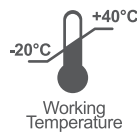
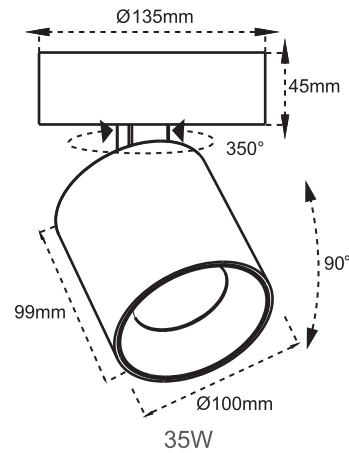
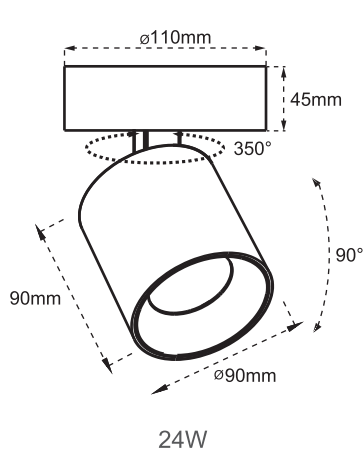

- Aluminum body and heat sink
- 350° rotatable, 90° tiltable
- cETL listed

Surface-mount & Pendant LED Downlights

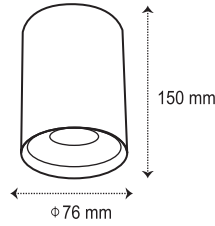

12 W

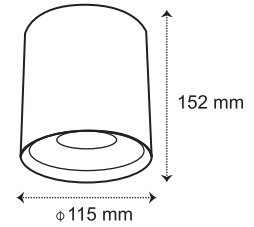

30 W

Product Code	Power	Lumen	CCT	Beam Angle
CL-DL2-RS-12W-30D-3K	12W	1080lm	3000K	30°
CL-DL2-RS-12W-30D-4K	12W	1080lm	4000K	30°
CL-DL2-RS-30W-35D-3K	30W	2400lm	3000K	35°
CL-DL2-RS-30W-35D-4K	30W	2400lm	4000K	35°

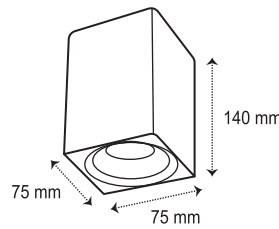

15 W

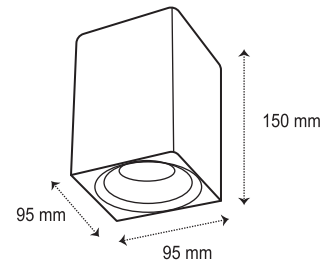

20 W

Product Code	Power	Lumen	CCT	Beam Angle
CL-DL2-SS-15W-30D-3K	15W	1350lm	3000K	30°
CL-DL2-SS-15W-30D-4K	15W	1350lm	4000K	30°
CL-DL2-SS-20W-30D-3K	20W	1800lm	3000K	30°
CL-DL2-SS-20W-30D-4K	20W	1800lm	4000K	30°

Body Color:

Black Body, Black Reflector | White Body, White Reflector

- Surface & Pendant installation
- Junction box cover is included
- OSRAM COB LED chip
- cETL approved

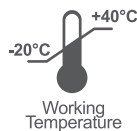

Surface-mount & Pendant LED Downlights



Product Code	Input Voltage	Power	Lumen	Color Temp	Beam Angle
CL-DL2-SD-12W-30D-3K	120VAC 50/60Hz	12W	1080lm	3000K	30°
CL-DL2-SD-12W-30D-4K	120VAC 50/60Hz	12W	1080lm	4000K	30°
CL-DL2-SD-20W-30D-3K	120VAC 50/60Hz	20W	1800lm	3000K	30°
CL-DL2-SD-20W-30D-4K	120VAC 50/60Hz	20W	1800lm	4000K	30°

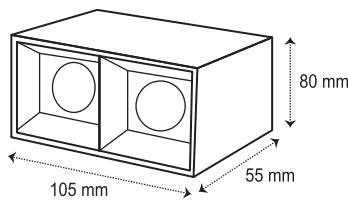

12W

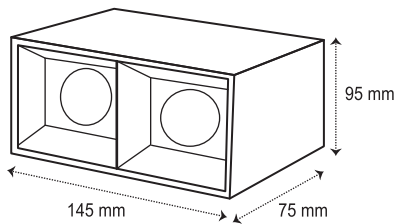

20W



Pendant kit

Body Color:

Black Body, Black Reflector | White Body, White Reflector

- Surface & Pendant installation
- Junction box cover is included
- OSRAM COB LED chip
- cETL approved



Surface-Mounted Downlights



CL-DL7-D20-5CCT



CL-DL7-S10-5CCT

Product Code	Input Voltage	Power	Lumen	Color Temp	Beam Angle
CL-DL7-S10-5CCT-WH	120VAC 50/60Hz	10W	750lm	5CCT Adjustable 2700K-3000K 3500K-4000K-5000K	55°
CL-DL7-S10-5CCT-BL					
CL-DL7-D20-5CCT-WH	120VAC 50/60Hz	20W	1500lm	5CCT Adjustable 2700K-3000K 3500K-4000K-5000K	55°
CL-DL7-D20-5CCT-BL					

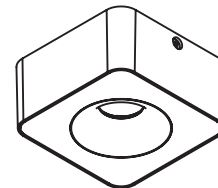
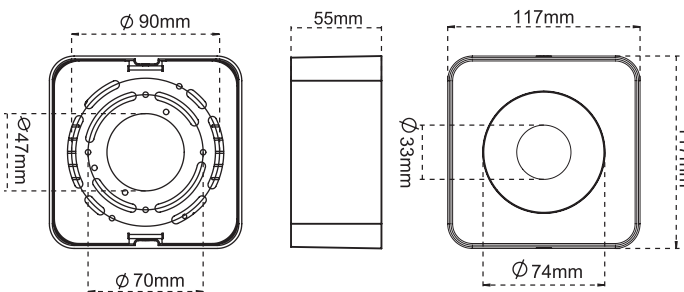

CL-DL7-S10-5CCT

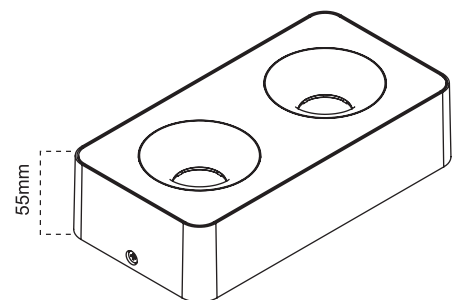
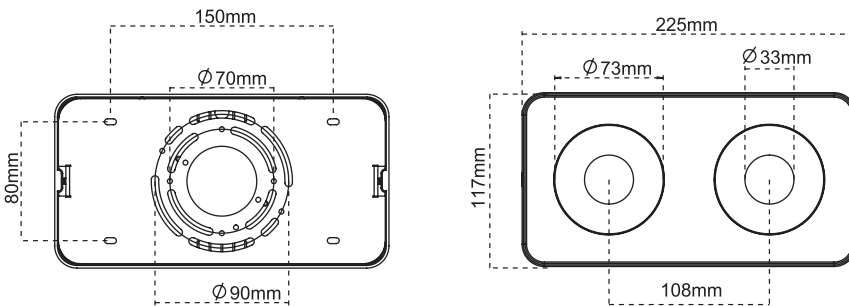

CL-DL7-D20-5CCT

AC
110V
50/60Hz

TRIAC
DIMMABLE

DAMP
LOCATION

PF
≥ 0.9

CRI
> 90

WARRANTY
5
YEARS

Lifetime
>50,000 hrs

Working Temperature

• cETL listed

Pendant LED Downlights



Product Code	Input Voltage	Power	Lumen	Color Temp	Beam Angle
CL-DL2-PR1-1032-3K	AC 120V	10W	1000lm	3000K	36°
CL-DL2-PR1-1032-4K	AC 120V	10W	1000lm	4000K	36°

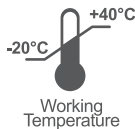
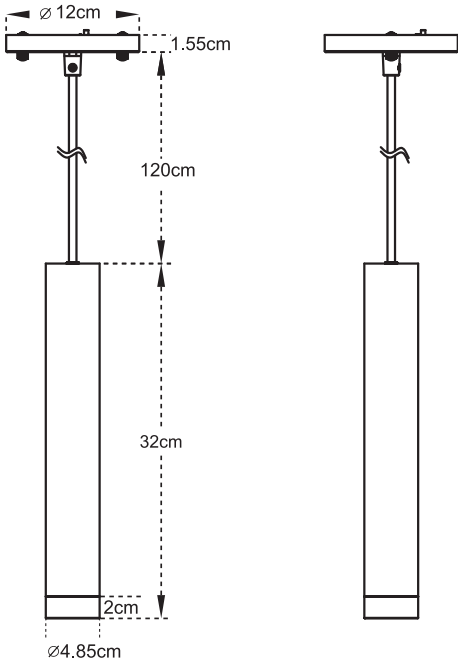

Available in White and Black body color

- Input Voltage: 120VAC 50/60Hz
- cETL approved

Recessed Linear Blade



CL-LB5-T1-10-38D



CL-LB10-T1-20-38D

Product Code	Input Voltage	Power	Lumen	Color Temp	Beam Angle
CL-LB5-T1-10-38D-3K	120VAC 50/60Hz	10W	600lm	3000K	38°
CL-LB5-T1-10-38D-4K	120VAC 50/60Hz	10W	600lm	4000K	38°
CL-LB10-T1-20-38D-3K	120VAC 50/60Hz	20W	1650lm	3000K	38°
CL-LB10-T1-20-38D-4K	120VAC 50/60Hz	20W	1650lm	4000K	38°

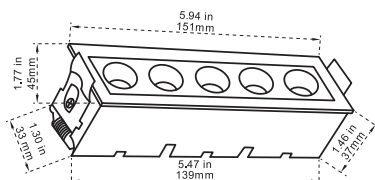

L5.79 * W1.38 in
L147 * W35 mm

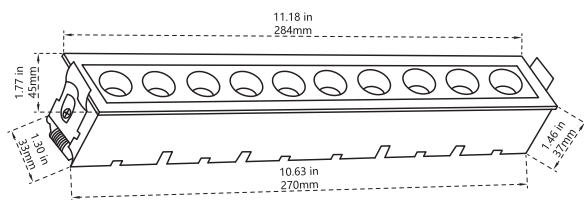

L11 * W1.38 in
L281 * W35 mm

- Body Color: Black | White
- Installation plate is available
- cETL certificate



Recessed Linear Spot Light



Product Code	Input Voltage	Power	Lumen	Color Temp	Beam Angle
CL-LBS2-6-5CCT-WH	120VAC 50/60Hz	6W	330lm	5CCT	40°
CL-LBS2-6-5CCT-BL	120VAC 50/60Hz	6W	330lm	Adjustable	40°
CL-LBS5-15-5CCT-WH	120VAC 50/60Hz	15W	830lm	2700K-3000K	40°
CL-LBS5-15-5CCT-BL	120VAC 50/60Hz	15W	830lm	3500K-4000K-5000K	40°

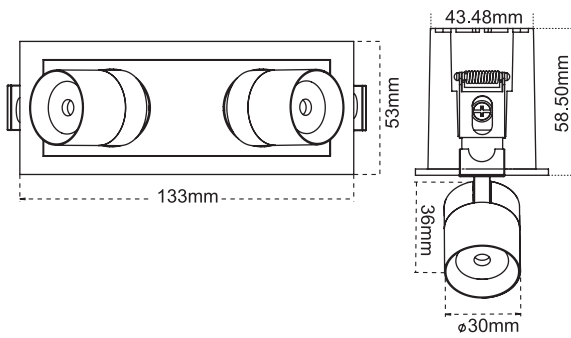

CL-LBS2-6-5CCT

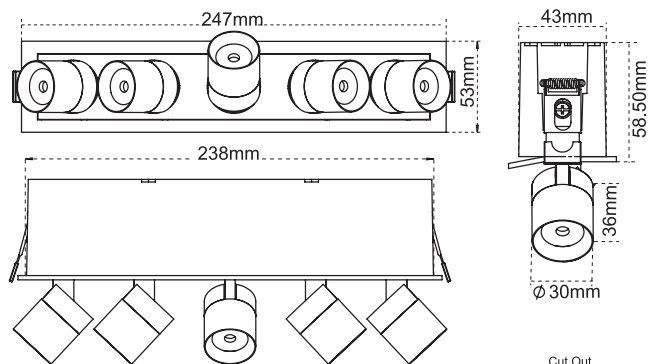

CL-LBS5-15-5CCT

• cETL listed

Anti-Glare Recessed Tilttable LED Downlights



Product Code	Input Voltage	Power	Lumen	Color Temp	Beam Angle
CL-DL5-R-12W-36D-5CCT-BL	120VAC 50/60Hz	12W	750lm	5CCT 2700K-3000K-3500K	36°
CL-DL5-R-12W-36D-5CCT-WH	120VAC 50/60Hz	12W	750lm	4000K-5000K	36°
CL-DL5-R-20W-36D-5CCT-BL	120VAC 50/60Hz	20W	1650lm	5CCT 2700K-3000K-3500K	36°
CL-DL5-R-20W-36D-5CCT-WH	120VAC 50/60Hz	20W	1650lm	4000K-5000K	36°

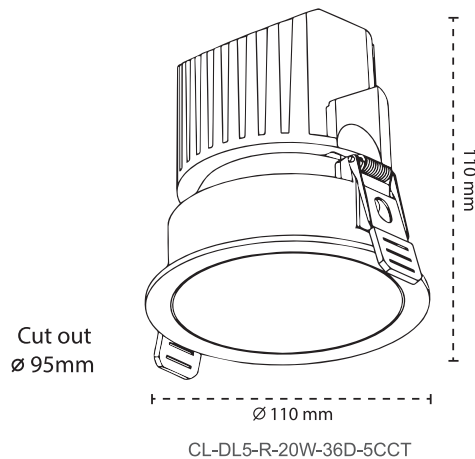
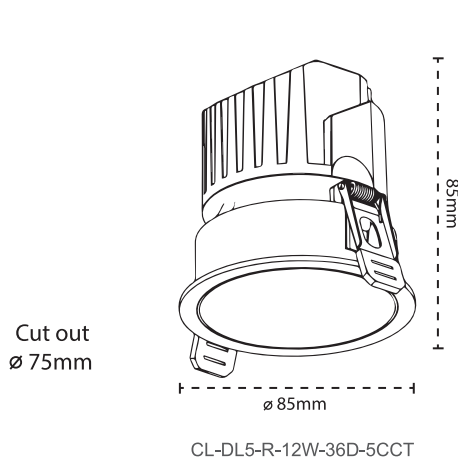

- Black Body, Black Reflector | White Body, White Reflector
- Installation plate is available
- cETL certificate

3-Inch Recessed Butterfly Downlights

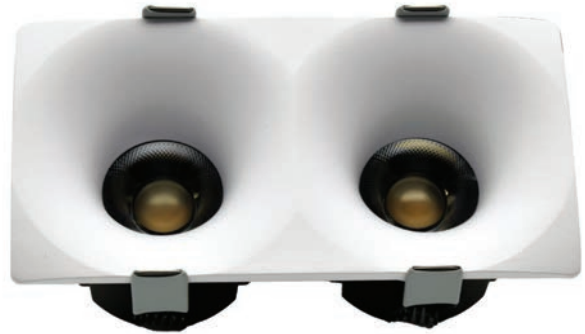

Product Code	Input Voltage	Power	Lumen	Color Temp	Beam angle	Body Color
CL-DL6-S9-5CCT	120-277 VAC	9W	840lm	5CCT Adjustable 2700K 3000K 3500K 4000K 5000K	38°	Available in White & Black
CL-DL6-D18-5CCT	120-277 VAC	18W	1640lm		38°	

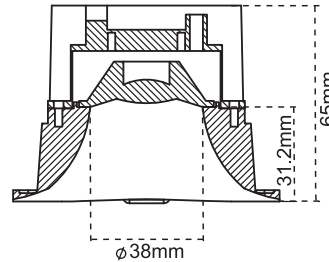
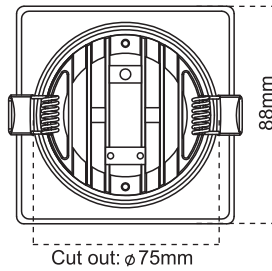

CL-DL6-S9-5CCT

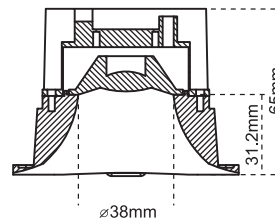
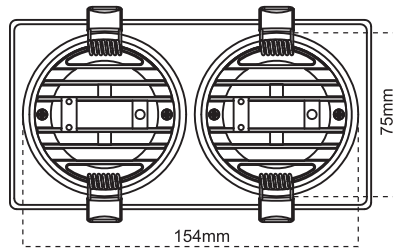
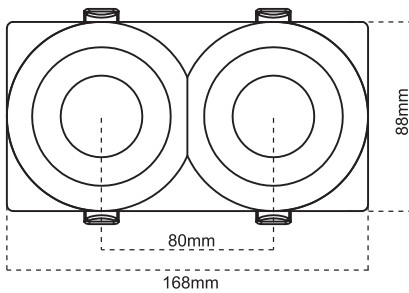

CL-DL6-D18-5CCT

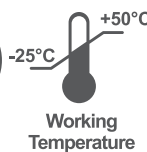

• cETL listed

Anti-glare Recessed Downlights



CL-DL1-S-15-36D



CL-DL1-D-30-36D

Product Code	Input Voltage	Power	Lumen	Color Temp	Beam Angle
CL-DL1-S-15-36D-3K	120VAC 50/60Hz	15W	1050lm	3000K	36°
CL-DL1-S-15-36D-4K	120VAC 50/60Hz	15W	1050lm	4000K	36°
CL-DL1-D-30-36D-3K	120VAC 50/60Hz	30W	2100lm	3000K	36°
CL-DL1-D-30-36D-4K	120VAC 50/60Hz	30W	2100lm	4000K	36°

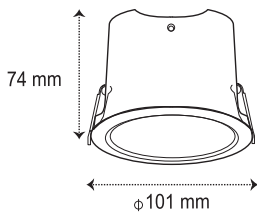

Cut Out

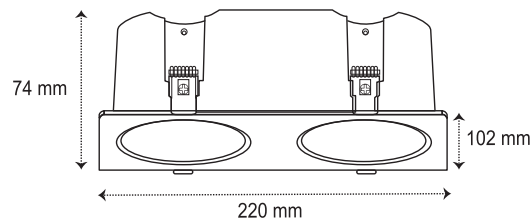

Cut Out



- Body Color: Black | White
- Reflector color: Black | White | Gold
- Installation plate is available
- cETL certificate



4-Inch
3.5-Inch
3-Inch
2-Inch

Modular LED Downlights

Interchangeable components for easy customization and maintenance.



2-Inch Modular LED Downlights



Product Code	Input Voltage	Power	Lumen	Color Temp	Beam Angle
CL-DL3-2007-38D-5CCT	120VAC 50/60Hz	7W	560lm	5CCT Adjustable 2700K,3000K,3500K,4000K,5000K	38°

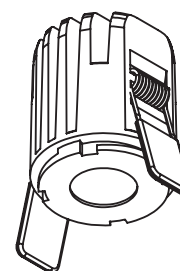
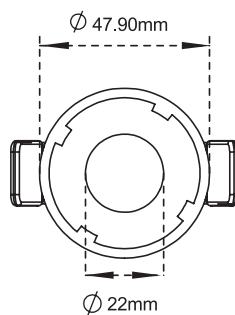
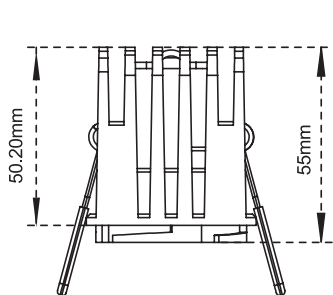

- Interchangeable components for easy customization and maintenance.
- Installation plate is available
- cETL certificate

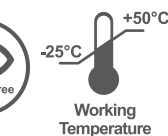

2-Inch Modular LED Downlights Frames

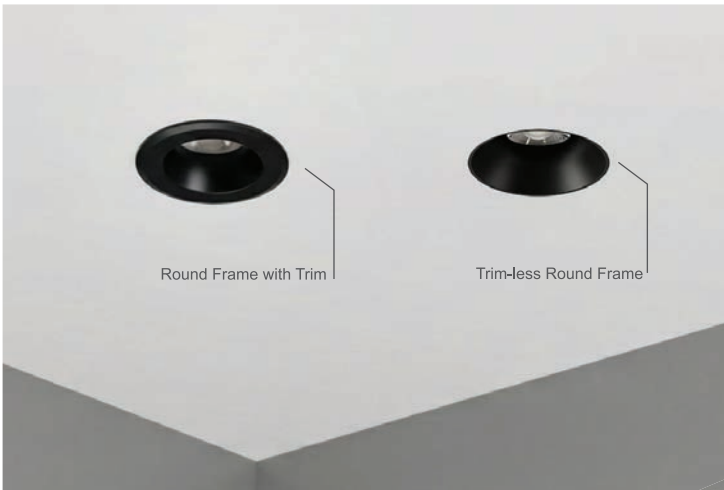

CL-DL3-2007-38D-5CCT
With Round Frame: CL-DL3-2R

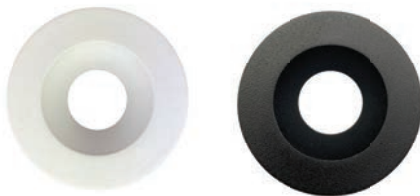

CL-DL3-2R

Round Frame with Trim
Body Color available in Black and White

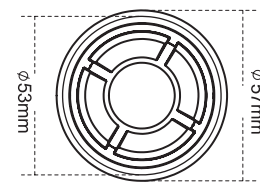
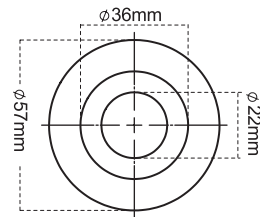

CL-DL3-2RT

Trim-less Round Frame
Body Color available in Black and White

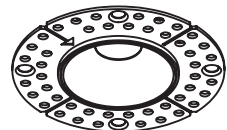
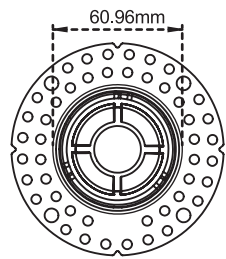
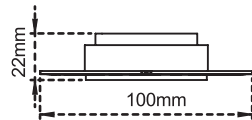

- cETL Certificate
- 5-Year Warranty

3-Inch Modular LED Downlights



CL-DL3-3009-40D-5CCT
With Round Frame: CL-DL3-3R



Product Code	Input Voltage	Power	Lumen	Color Temp	Beam Angle
CL-DL3-3009-40D-5CCT	120VAC 50/60Hz	9W	750lm	5CCT Adjustable 2700K,3000K,3500K,4000K,5000K	40°

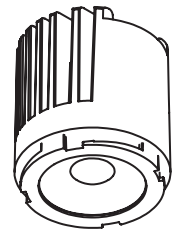
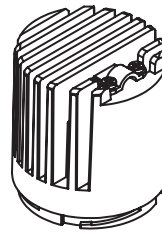
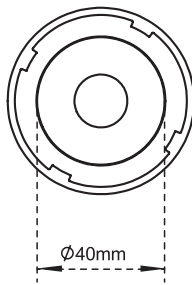
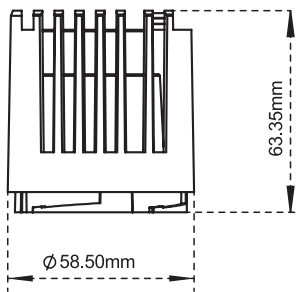

- Interchangeable components for easy customization and maintenance.
- Frames available in round or square shapes, with trim or trimless options, in white or black finishes.
- Installation plate is available
- cETL certificate

3-Inch DIM to Warm Modular LED Downlights



Product Code	Input Voltage	Power	Lumen	Color Temp	Beam Angle
CL-DL3-DTW-3009-40D	120VAC 50/60Hz	9W	780lm	DIM TO WARM 1800K > 3000K	40°

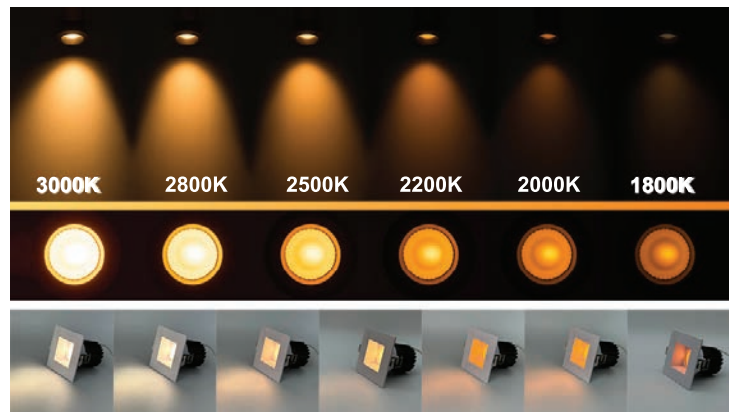
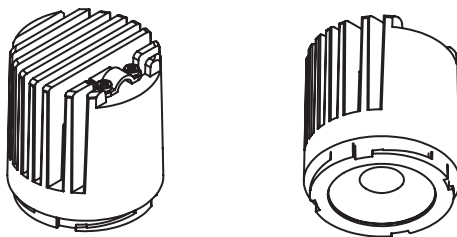
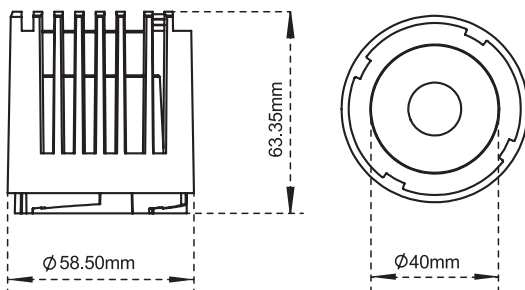

- Interchangeable components for easy customization and maintenance.
- Frames available in round or square shapes, with trim or trimless options, in white or black finishes.
- Installation plate is available
- cETL certificate

3-Inch Modular LED Downlights Frames

CL-DL3-3R
Round Frame with Trim

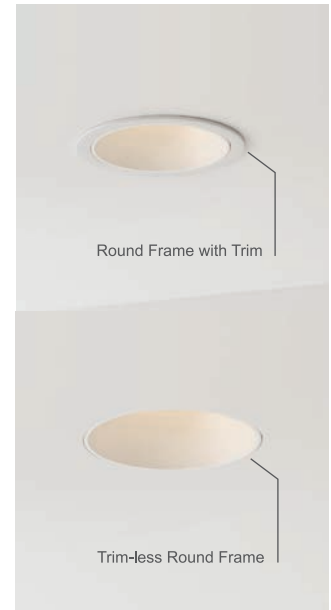

Cut Out
75mm

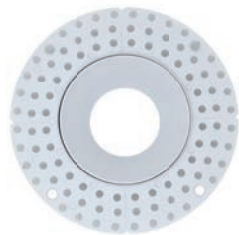
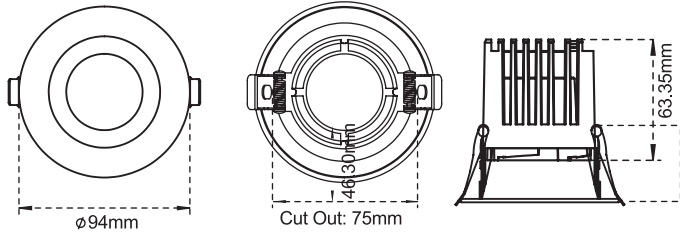

Cut Out
80mm

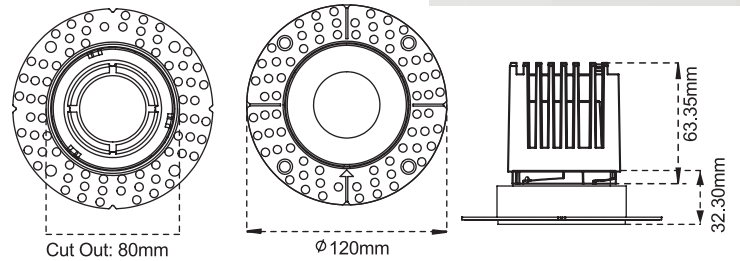

CL-DL3-3RT
Trim-less Round Frame



Cut Out
75mm

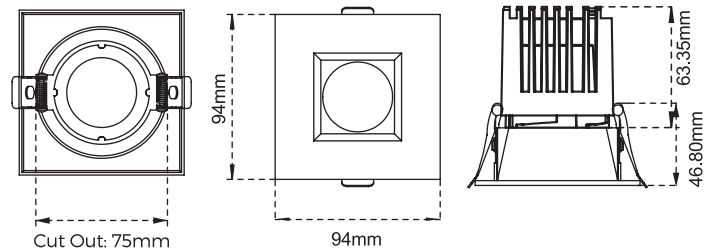

CL-DL3-3S
Square Frame with Trim

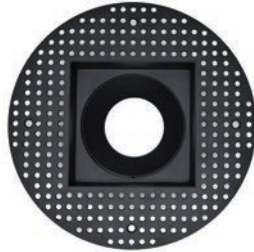
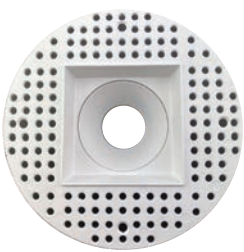

Cut Out
90mmx90mm

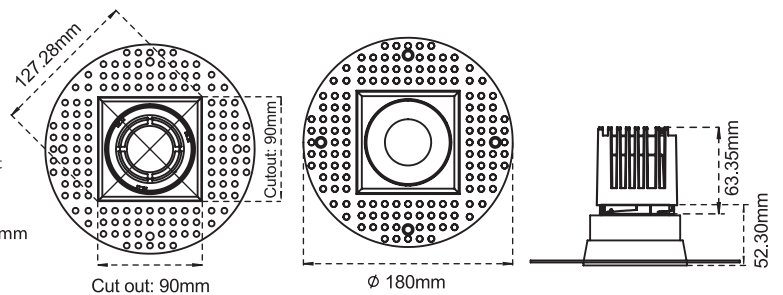

CL-DL3-3ST
Trim-less Square Frame

- Body Color available in Black and White
- cETL Certificate
- 5-Year Warranty

3-inch Modular LED Downlights | Tilttable Round Frames



CL-DL3-T3R-WH
Tilttable Round Frame with Trim



CL-DL3-T3R-BL
Tilttable Round Frame with Trim

Cut Out
88 mm

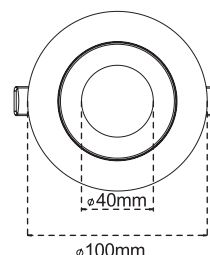
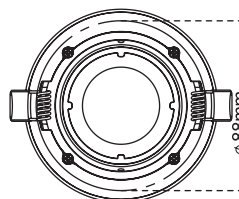
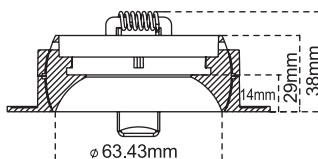

CL-DL3-T3RT-WH
Trim-less Tilttable Round Frame

Tilttable
~30°

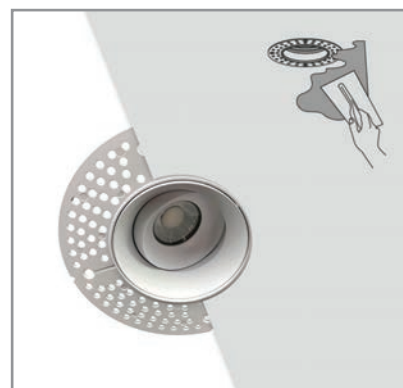

CL-DL3-T3RT-BL
Trim-less Tilttable Round Frame

Cut Out
95 mm

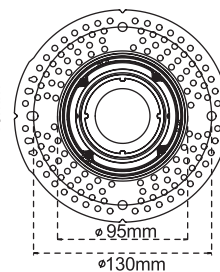
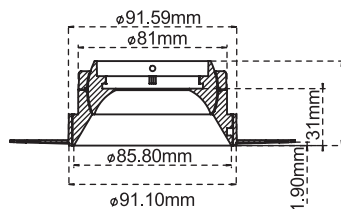
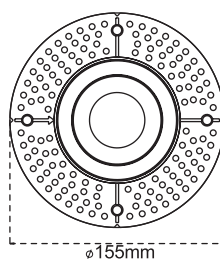

- cETL Certificate
- 5-Year Warranty

3-inch Modular LED Downlights | Double Frames



CL-DL3-3R-D-WH
Double Round Frame With Trim

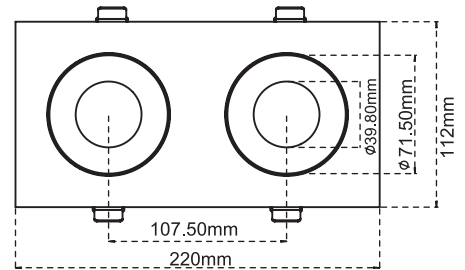
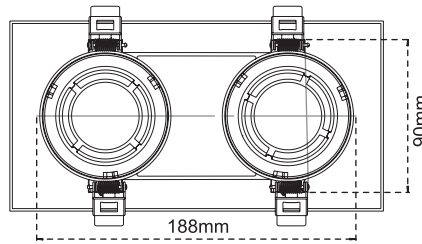

CL-DL3-3R-D-BL
Double Round Frame With Trim

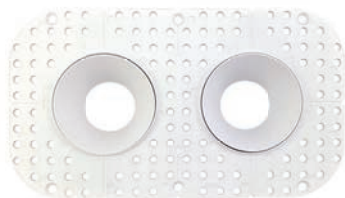

CL-DL3-3RT-D-WH
Trim-less Double Round Frame

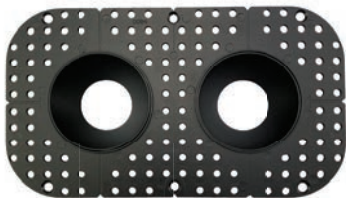
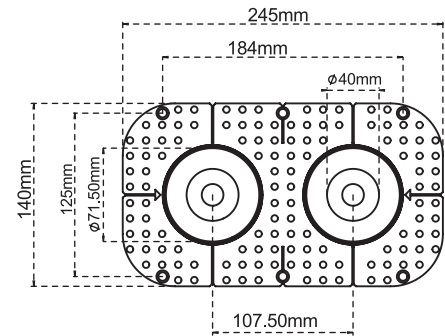
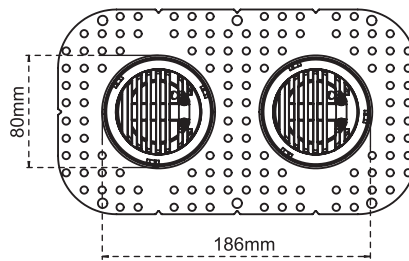

CL-DL3-3RT-D-BL
Trim-less Double Round Frame

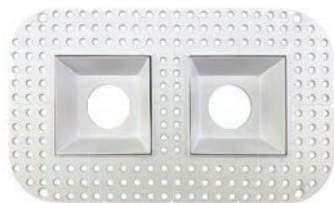

CL-DL3-3ST-D-WH
Trim-less Double Square Frame

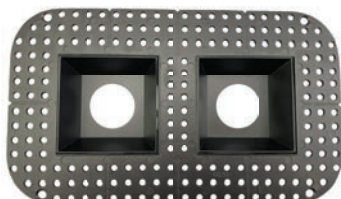
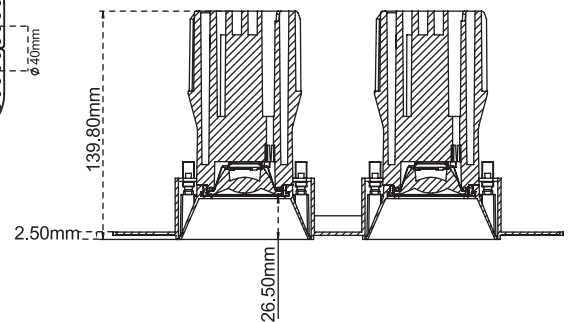
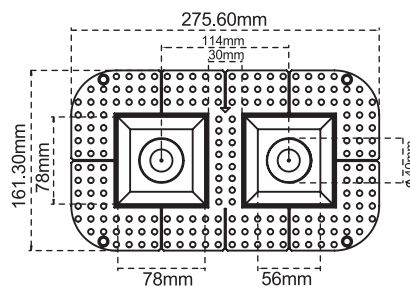

CL-DL3-3ST-D-BL
Trim-less Double Square Frame

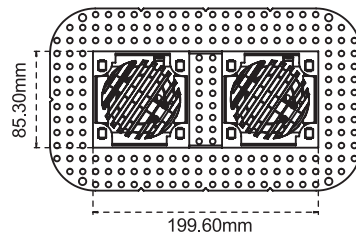

3.5-Inch Modular LED Downlights



Product Code	Input Voltage	Power	Lumen	Color Temp	Beam angle
CL-DL3-3512-40D-5CCT	120VAC 50/60Hz	12W	1050lm	5CCT Adjustable 2700K,3000K,3500K,4000K,5000K	40°

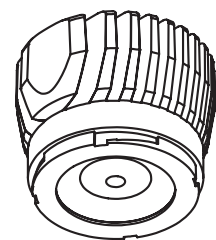
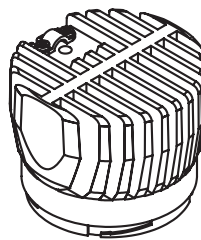
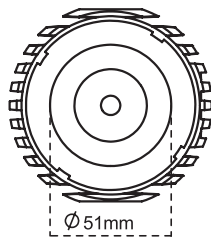
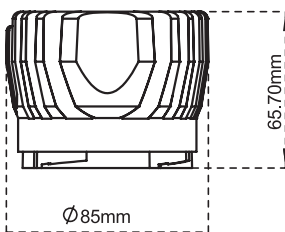

Installation plate is available

- Interchangeable components for easy customization and maintenance.
- Frames available in round or square shapes, with trim or trimless options, in white or black finishes.
- cETL certificate

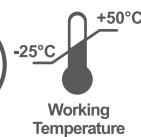



Modular LED Downlights
DIM TO WARM

3.5-Inch DIM to Warm Modular LED Downlights

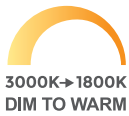

Product Code	Input Voltage	Power	Lumen	Color Temp	Beam Angle
CL-DL3-DTW-3512-40D	120VAC 50/60Hz	12W	960lm	DIM TO WARM 1800K > 3000K	40°

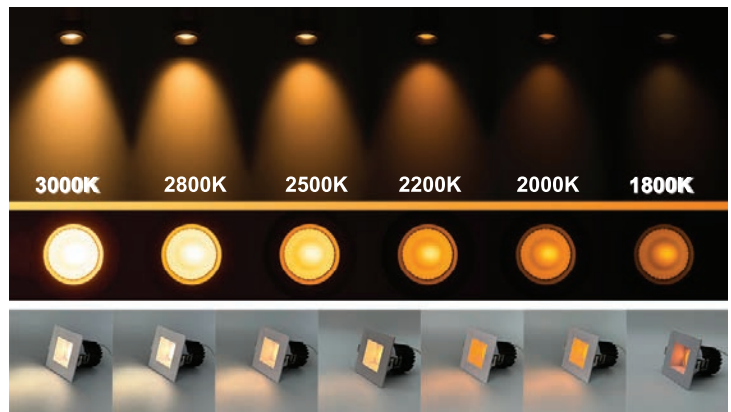
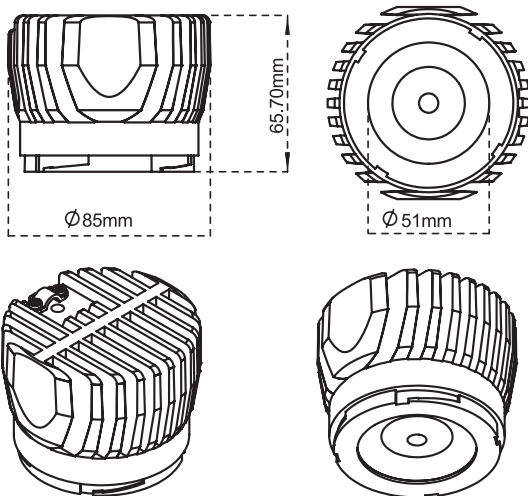

- Interchangeable components for easy customization and maintenance.
- Frames available in round or square shapes, with trim or trimless options, in white or black finishes.
- Installation plate is available
- cETL certificate



3.5-Inch Modular LED Downlights Frames

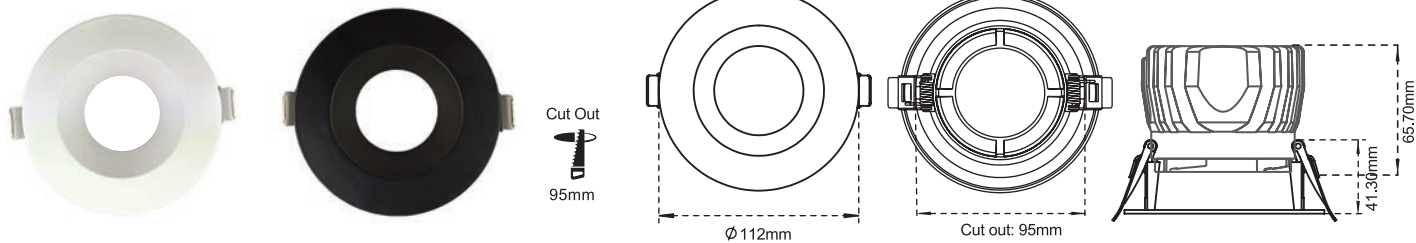

CL-DL3-3.5R
Round Frame with Trim

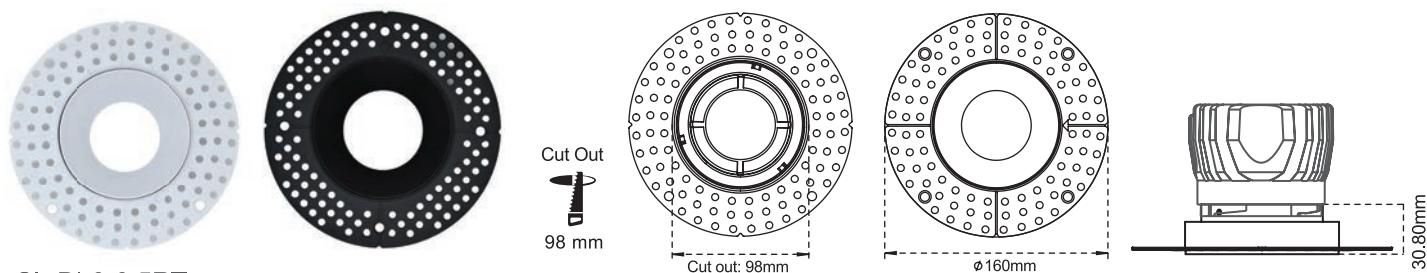

CL-DL3-3.5RT
Trim-less Round Frame

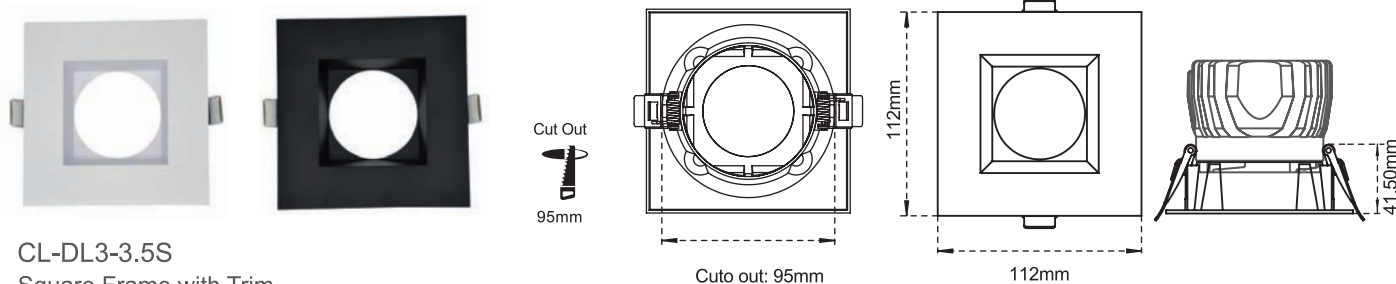

CL-DL3-3.5S
Square Frame with Trim

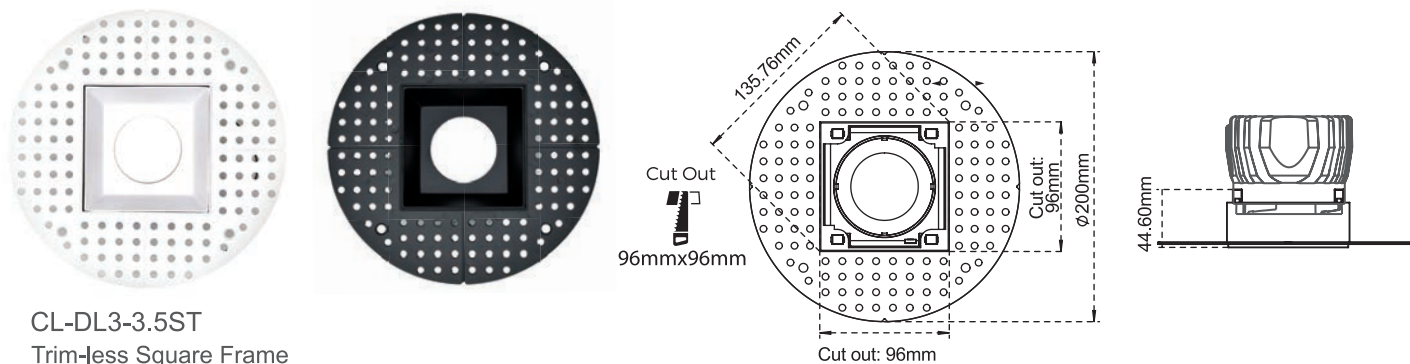

CL-DL3-3.5ST
Trim-less Square Frame

- Body Color available in Black and White
- cETL Certificate
- 5-Year Warranty

4-Inches Modular LED Downlights



CL-DL3-4012-40D-5CCT
With Round Frame: CL-DL3-4R

Product Code	Input Voltage	Power	Lumen	Color Temp	Beam angle
CL-DL3-4012-40D-5CCT	120VAC 50/60Hz	12W	1100lm	5CCT Adjustable 2700K,3000K,3500K,4000K,5000K	40°

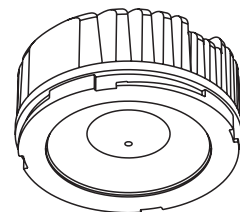
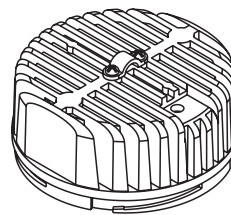
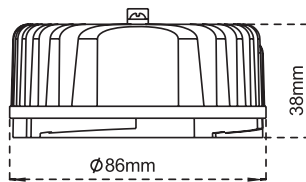
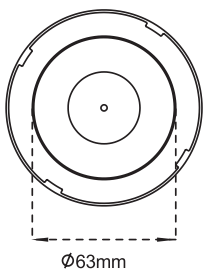

Installation plate is available

- Interchangeable components for easy customization and maintenance.
- Frames available in round or square shapes, with trim or trimless options, in white or black finishes.
- cETL certificate

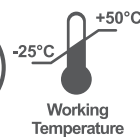

4-Inch DIM to Warm Modular LED Downlights

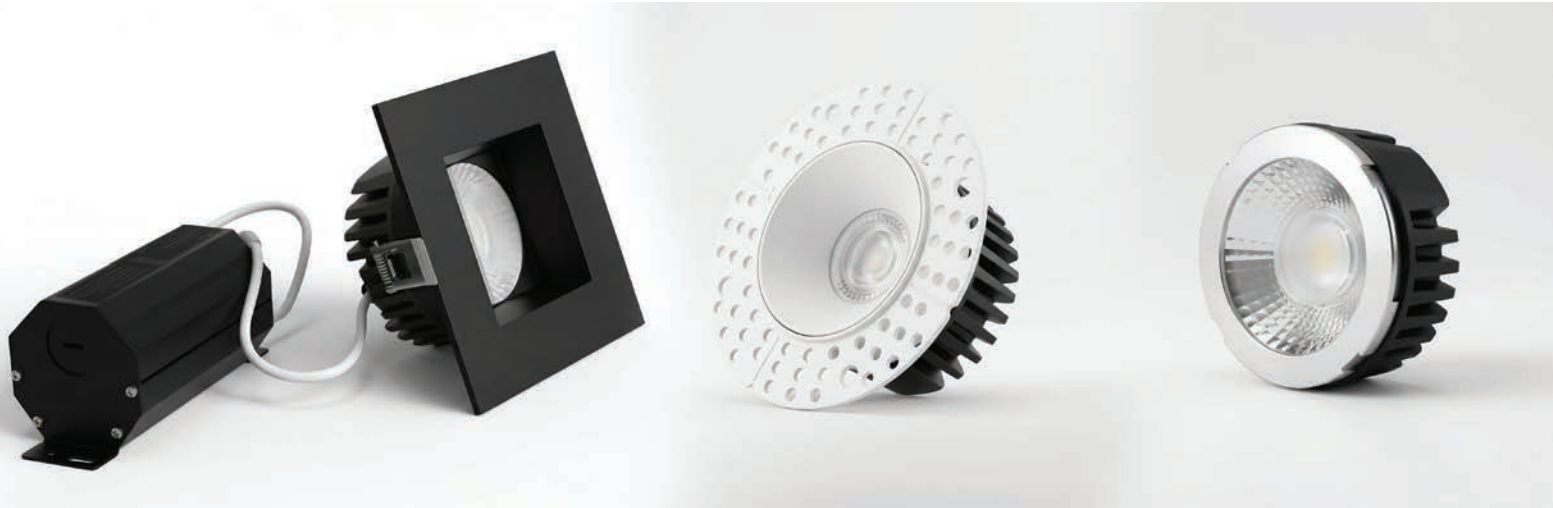
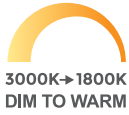

Product Code	Input Voltage	Power	Lumen	Color Temp	Beam Angle
CL-DL3-DTW-4012-40D	120VAC 50/60Hz	12W	1100lm	DIM TO WARM 1800K > 3000K	40°

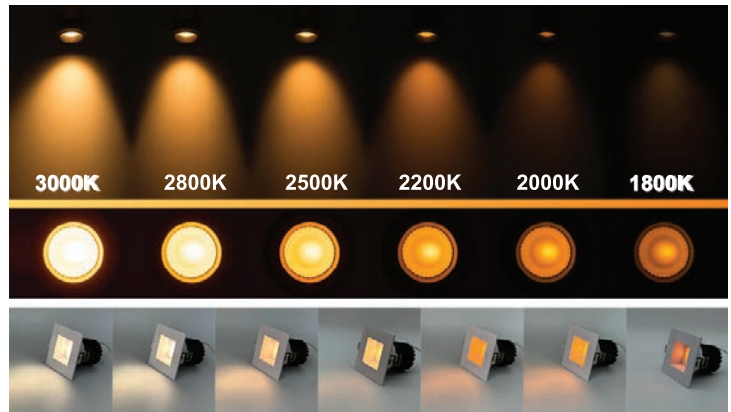
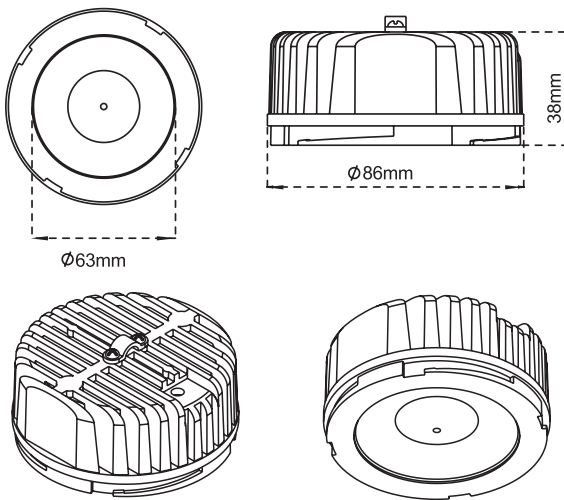

- Interchangeable components for easy customization and maintenance.
- Frames available in round or square shapes, with trim or trimless options, in white or black finishes.
- Installation plate is available
- cETL certificate



4-inch Modular LED Downlights Frames

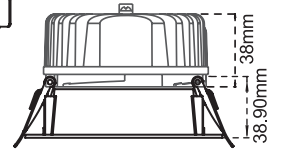
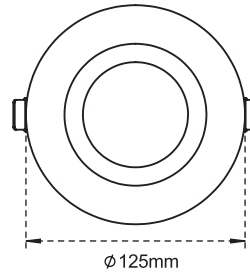
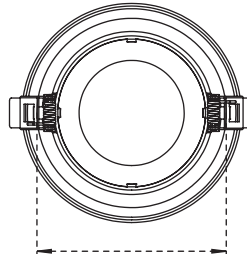

CL-DL3-4R
Round Frame with Trim

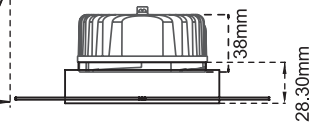
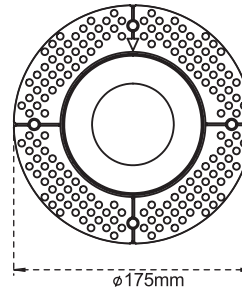
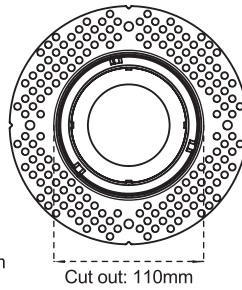
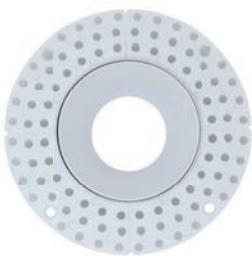

CL-DL3-4RT
Trim-less Round Frame

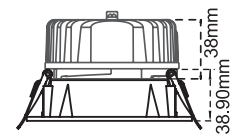
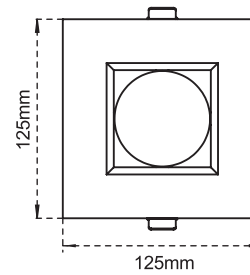
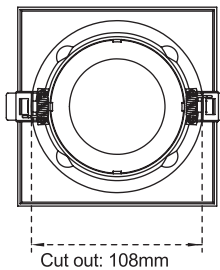

CL-DL3-4S
Square Frame with Trim

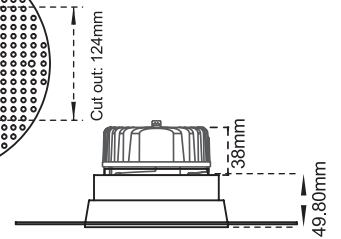
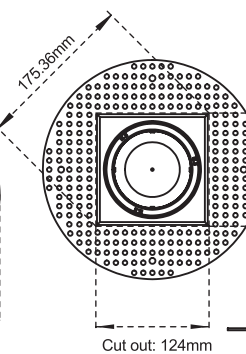
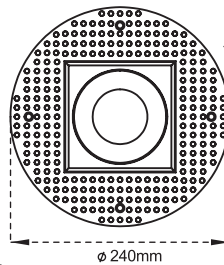
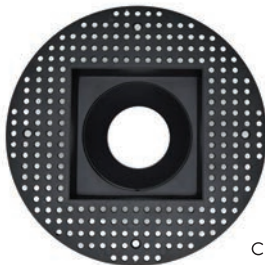
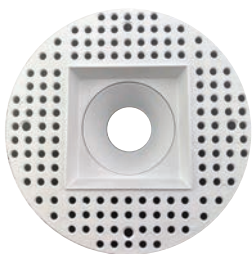

CL-DL3-4ST
Trim-less Square Frame

- Body Color available in Black and White
- cETL Certificate
- 5-Year Warranty

Round Baffle Downlights

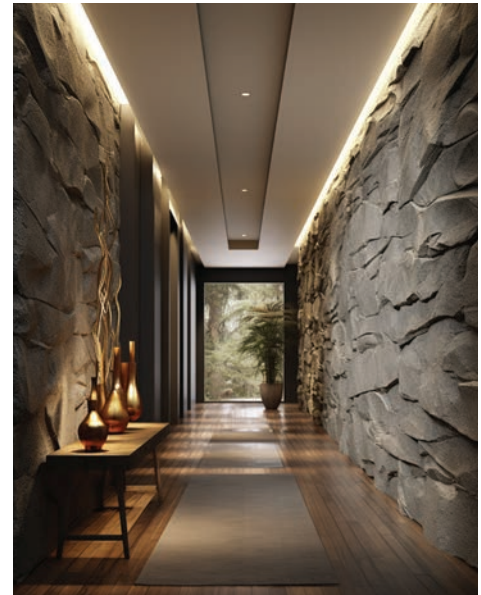

Product Code	Input Voltage	Power	Lumen	Color Temp	Body Color	Size
CL-BF1-R3509-3CCT-WH	120-277 VAC	9W	770lm	3 CCT Adjustable (3000K 4000K 5000K)	White	3.5-Inch
CL-BF1-R3509-3CCT-BL	120-277 VAC	9W	770lm		Black	3.5-Inch
CL-BF1-R4012-5CCT-WH	120-277 VAC	12W	1000lm	5 CCT Adjustable 2700K 3000K 3500K 4000K 5000K	White	4-Inch
CL-BF1-R4012-5CCT-BL	120-277 VAC	12W	1000lm		Black	4-Inch

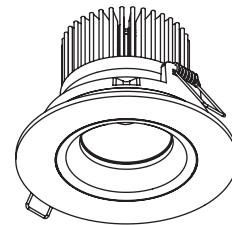
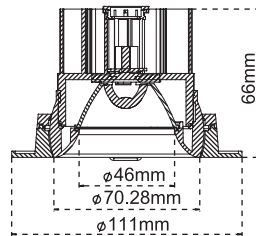
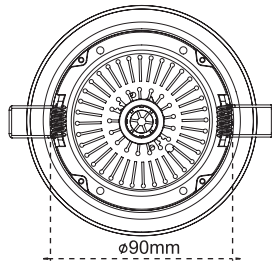

CL-BF1-R3509-3CCT

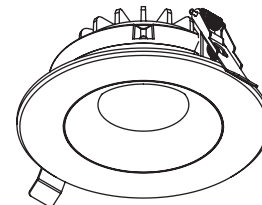
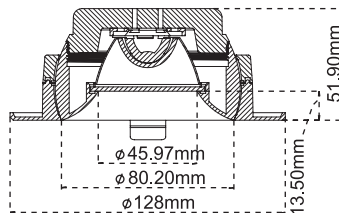
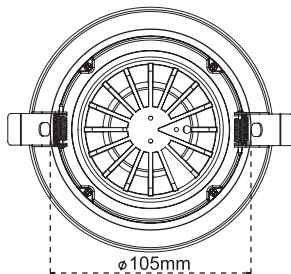

CL-BF1-R4012-5CCT

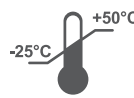

• cETL listed

Square Baffle Downlights



Product Code	Input Voltage	Power	Lumen	Color Temp	Body Color	Size
CL-BF1-S3509-5CCT-WH	120-277 VAC	9W	770lm	5CCT Adjustable 2700K 3000K 3500K 4000K 5000K	White	3.5 -Inch
CL-BF1-S3509-5CCT-BL					Black	
CL-BF1-S4012-5CCT-WH	120-277 VAC	12W	1000lm	5CCT Adjustable 2700K 3000K 3500K 4000K 5000K	White	4 -Inch
CL-BF1-S4012-5CCT-BL					Black	

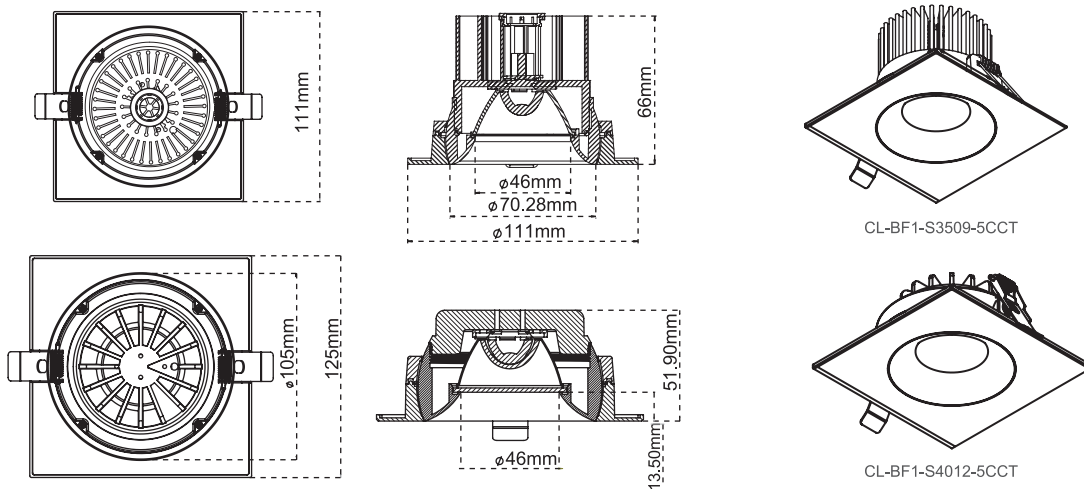

AC
110V
50/60Hz

IC
RATED

TRIAC
DIMMABLE

WET
LOCATION

Flicker Free

5CCT
COLOUR
CHANGING

CRI
> 90

5
YEARS
WARRANTY

Lifetime
>50,000 hrs

-25°C +50°C
Working Temperature

38°
Beam Angle

• cETL listed

Star Series Downlights

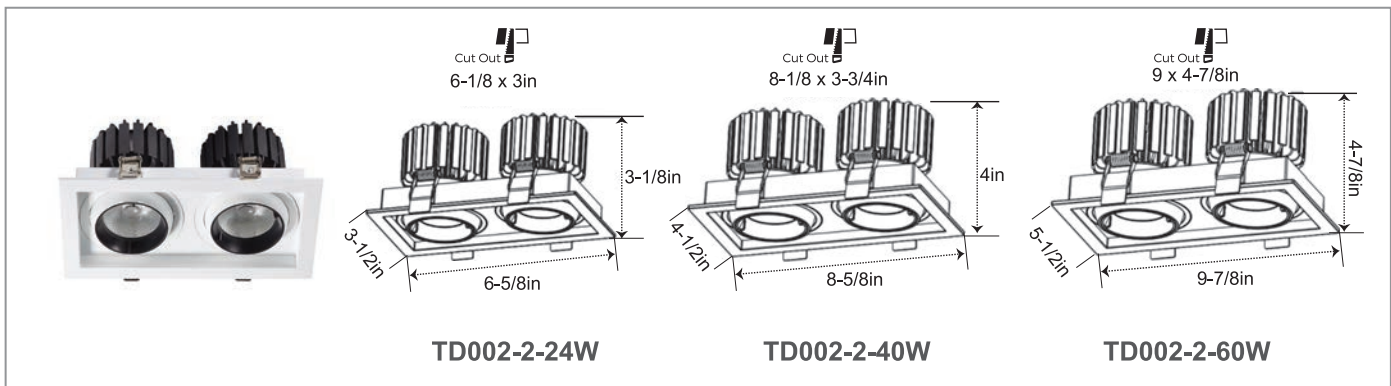
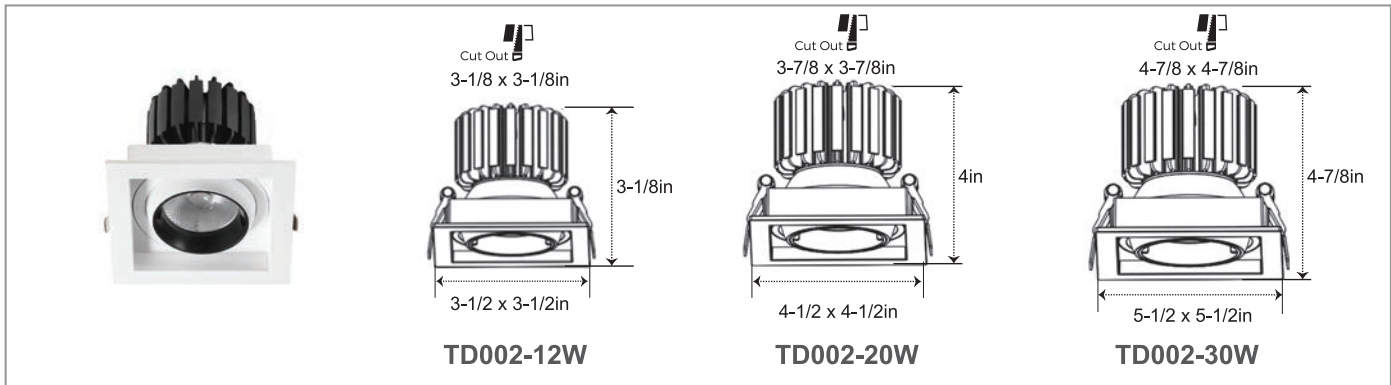
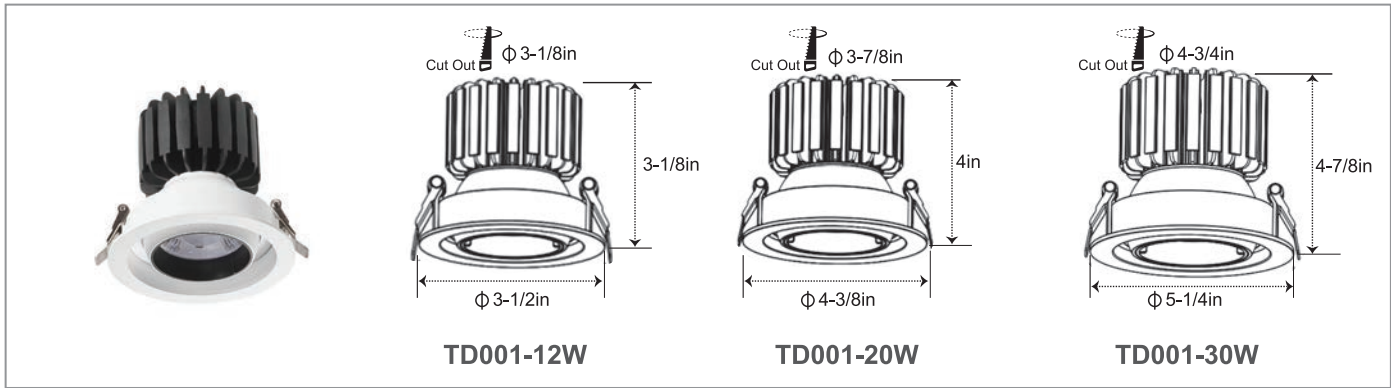

Body color: White housing with Black or White inner ring

Star series downlights are project-base and available in following options:

- Single head downlights in 12W, 20W, and 30W
- Double head downlights in 24W, 40W, and 60W
- Fixture lumen output: 80 to 90 lumen per Watt
- Beam angle: 15°, 24°, and 36°
- LED modules: Citizen, Osram, Philips, Luminus
- Phase-cut and 0-10V dimmable drivers are available, 100-277VAC 50-60Hz
- Color temperature: 2700K, 3000K, 4000K, 5000K, 6000K or customized CCT
- CRI >90 or CRI>95
- UGR<19
- Single-head downlight in round or square shapes



Recessed LED Gimbal Lights

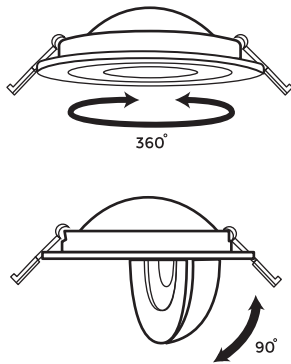

Product Code	Input Voltage	Power	Lumen	Beam Angle	CCT	Body Color	Size
CL-DM-3.5-8-5CCT-WH	90-130 VAC	8 W	830 lm	40°	5CCT Adjustable	White	3.5inch
CL-DM-3.5-8-5CCT-BL	90-130 VAC	8 W	830 lm	40°	2700K 3000K	Black	3.5inch
CL-DM-49-5CCT-WH	90-130 VAC	9 W	950 lm	40°	3500K 4000K	White	4 inch
CL-DM-49-5CCT-BL	90-130 VAC	9 W	950 lm	40°	5000K	Black	4 inch

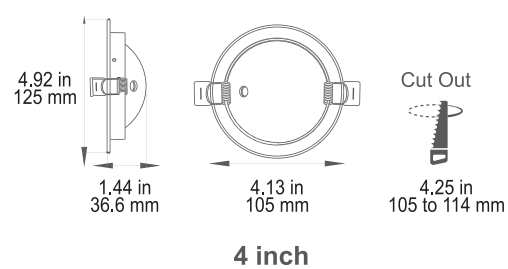
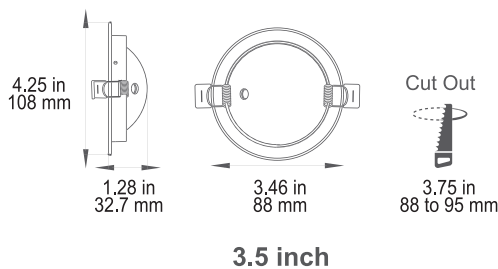

- Durable aluminum body
- Isolated driver, prevents electric shock
- Safe to be in direct contact with insulation
- FT4 wire, Airtight
- No flicker
- cETL approved

Recessed LED Slim Panels With Night Light

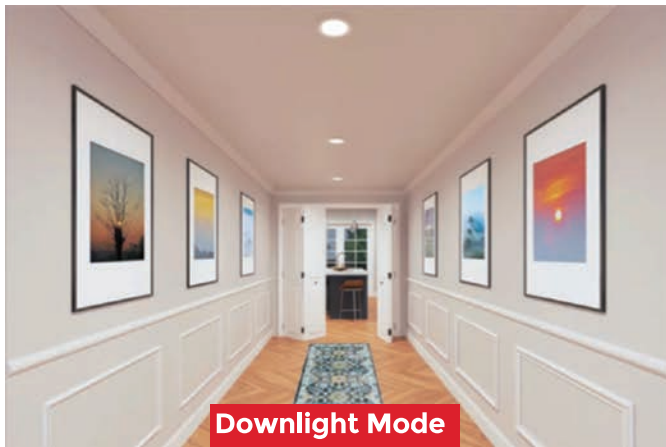

Downlight Mode

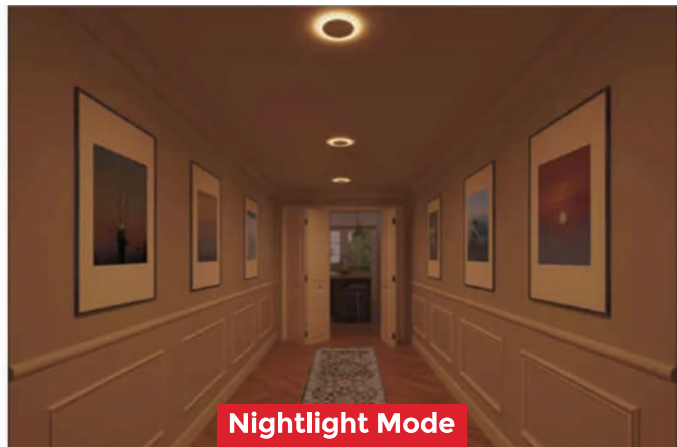

Nightlight Mode

Product Code	Input Voltage	Power	Lumen	Beam Angle	CCT	Body Color	Size
CL-DSNL-49-5CCT-WH	90-130VAC	9+2 W	800 lm	120°	5CCT Adjustable	White	4 inch
CL-DSNL-49-5CCT-BL	90-130VAC	9+2 W	800 lm	120°	2700K, 3000K, 3500K 4000K, 5000K	Black	4 inch

- Dual-mode downlight with 2200K night light
- Switch mode within 3 seconds
- Isolated driver, prevents electric shock
- Safe to be in direct contact with insulation
- FT4 wire, Airtight
- No flicker
- cETL approved

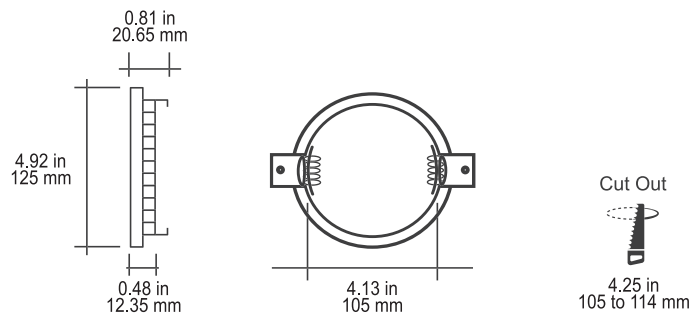

Recessed LED Slim Panels



Product Code	Input Voltage	Power	Lumen	Beam Angle	CCT	Body Color	Size
CL-DS-36-5CCT-WH	90-130VAC	6 W	530 lm	120°	5CCT	White	3 inch
CL-DS-49-5CCT-WH	90-130VAC	9 W	800 lm	120°	Adjustable 2700K	White	4 inch
CL-DS-49-5CCT-BL	90-130VAC	9 W	800 lm	120°	3000K	Black	4 inch
CL-DS-612-5CCT-WH	90-130VAC	12 W	1060 lm	120°	3500K	White	6 inch
CL-DS-612-5CCT-BL	90-130VAC	12 W	1060 lm	120°	4000K 5000K	Black	6 inch

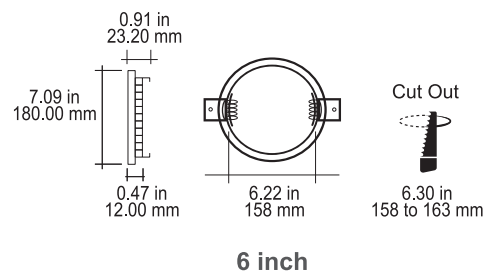
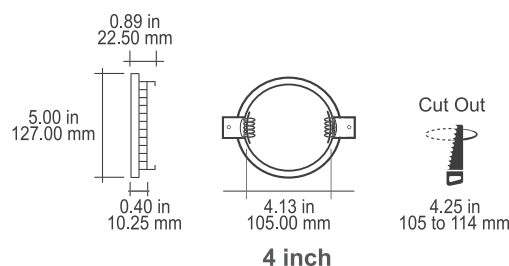
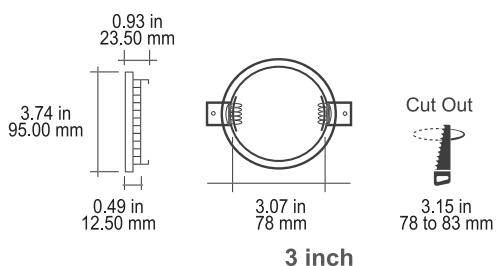

- Low-profile durable aluminum body
- Isolated driver, prevents electric shock
- Safe to be in direct contact with insulation
- Compatible with soffit installation and can be plenum installed in shallow spaces
- FT4 wire, Airtight
- No flicker
- cETL approved

Backlit LED Panels



Low Bay DLC Premium Listed



Product Code	Input Voltage	Power	Lumen	CCT	Panel Size
CL-PL2-1x4-40-5CCT-PA5	120-347VAC	Adjustable 20W-25W-30W	125lm/W	5CCT Adjustable 3000K	1x4 ft
CL-PL2-2x2-40-5CCT-PA5	120-347VAC	40W-45W	125lm/W	3500K 4000K 5000K	2x2 ft
CL-PL2-2x4-50-5CCT-PA5	120-347VAC	Adjustable 30W-35W-40W-45W-50W	125lm/W	6500K	2x4 ft

- Surface mount accessories are available.
- Backlit, uniform light with longer lifetime
- Galvanized Steel housing
- PMMA lens, No-yellowish outlook
- No flicker
- cETL approved

1.63inch
(4.16cm)

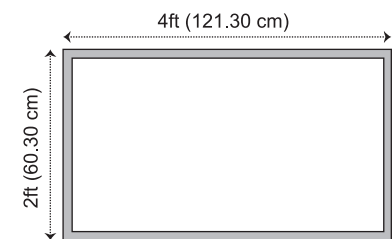
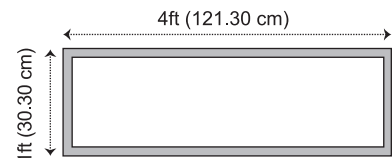
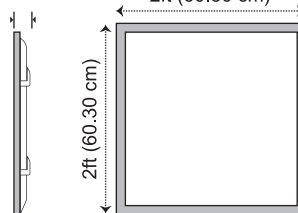

AC
110V
50/60Hz

IC
RATED

0-10V
DIMMABLE

IP20

PF
≥0.9

CRI
>80

WARRANTY
5
YEARS

Lifetime
>50,000 hrs

120°
Beam Angle

Mini LED Spot Lights



Product Code	Input Voltage	Power	Lumen	CCT	Beam Angle	Body Color
CL-DL02-2.5-24-3K-WH	24VDC	2.5 W	175lm	3000K	30°	White
CL-DL02-2.5-24-3K-SL	24VDC	2.5 W	175lm	3000K	30°	Silver
CL-DL02-2.5-24-4K-WH	24VDC	2.5 W	175lm	4000K	30°	White
CL-DL02-2.5-24-4K-SL	24VDC	2.5 W	175lm	4000K	30°	Silver

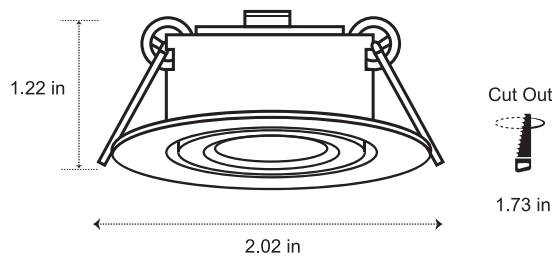

AC
110V
50/60Hz

IC
RATED

DIMMABLE

IP20

PF
≥0.9

CRI
>80

WARRANTY
3
YEARS

Lifetime
>30,000 hrs

Working Temperature

- cETL approved
- Aluminum body

Round and Square Step Lights



Product Code	Input Voltage	Power	Lumen	CCT	Surface
CL-STEP1-R-3k	24VDC	3W	80lm/W	3000K	Round
CL-STEP1-R-4k	24VDC	3W	80lm/W	4000K	Round
CL-STEP1-S-3k	24VDC	3W	80lm/W	3000K	Square
CL-STEP1-S-4k	24VDC	3W	80lm/W	4000K	Square

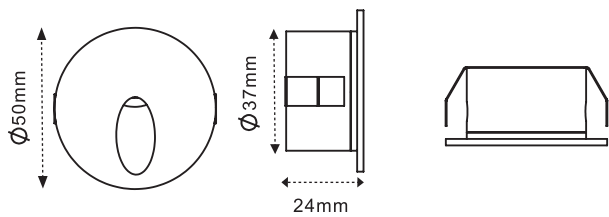

CL-STEP1-R

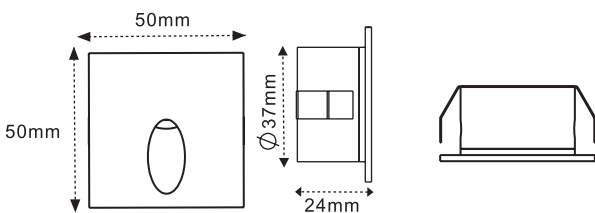

- Body Color available in Black and White
- cETL Certificate

IP Rated Step Lights



Product Code	Input Voltage	Power	Lumen	Color Temp	Body Color
CL-STEP2-H-5CCT-WH	12-24VAC/VDC	3W	80lm	5 CCT Adjustable	White
CL-STEP2-H-5CCT-BL	12-24VAC/VDC	3W	60lm	(2700K 3000K 3500K 4000K 5000K)	Black
CL-STEP2-V-5CCT-WH	12-24VAC/VDC	3W	110lm	5 CCT Adjustable	White
CL-STEP2-V-5CCT-BL	12-24VAC/VDC	3W	55lm	(2700K 3000K 3500K 4000K 5000K)	Black

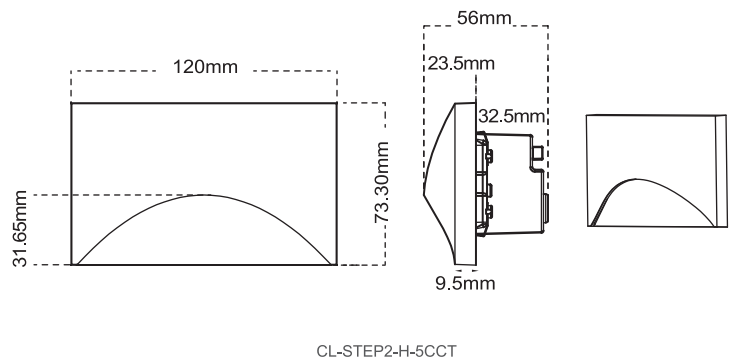
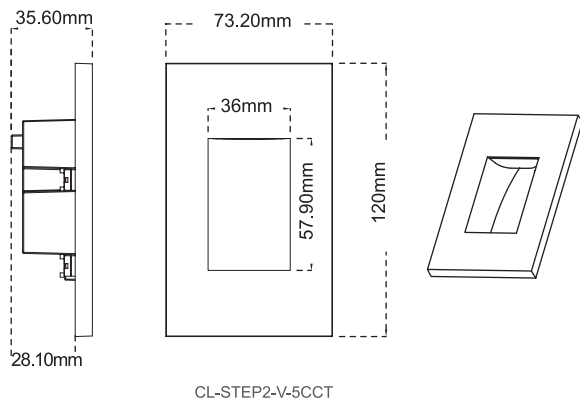

• cETL Certificate

Round LED Puck Light



Input Voltage	Power	Lumen	CRI	CCT
24VDC	3 W	220lm	>80	3CCT Adjustable 3000K- 4000K- 5000K

Product Code	Body Color
CL-Puck300F-324-3CCT-WH	White
CL-Puck300F-324-3CCT-BL	Black
CL-Puck300F-324-3CCT-SN	Satin Nickel

- Surface mounted or recessed installation
- Aluminum body with polystyrene diffuser
- cETL Certificate

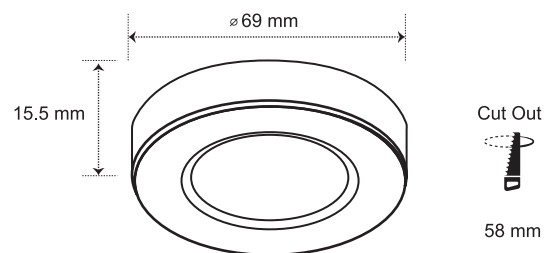

-20°C +40°C
Working Temperature

Vanity Lights



Product Code	Input Voltage	Power	Color Temp	Lumen	Color
CL-VL-1375M-20W-5CCT-BL	100-277VAC	20W	5CCT Adjustable 2700K-3000K	110lm/W	Black
CL-VL-1375M-20W-5CCT-GL			3500K-4000K-5000K		Gold

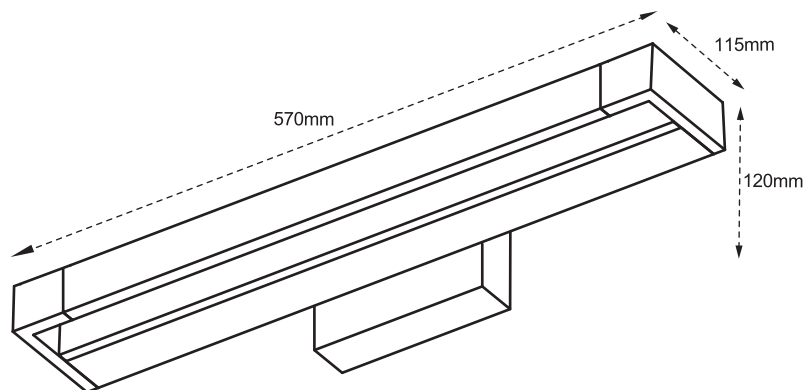

AC
110V
50/60Hz

DAMP
LOCATIONS

TRIAC
DIMMABLE

CRI
>80

WARRANTY
3
YEARS

Lifetime
>30,000 hrs

Working Temperature

- Isolated flicker free driver
- OSRAM LED
- cETL certificate

Vanity Lights



Product Code	Input Voltage	Power	Color Temp	Lumen	Color
CL-VL-1334L-26W-5CCT-BL	100-277VAC	26W	5CCT Adjustable	115lm/W	Black
CL-VL-1334L-26W-5CCT-CH			2700K-3000K		Chrome
CL-VL-1334L-26W-5CCT-GL			3500K-4000K-5000K		Gold

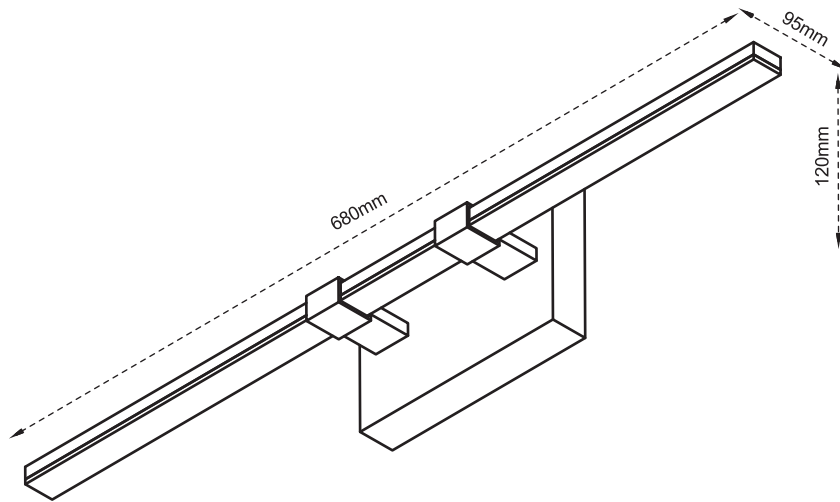

- Isolated flicker free driver
- OSRAM LED
- cETL certificate

Vanity Lights

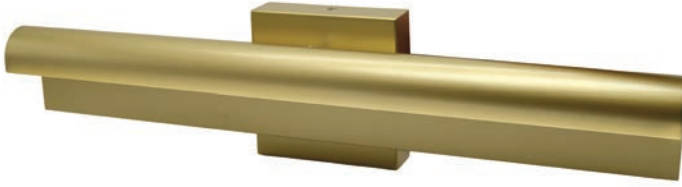

Product Code	Input Voltage	Power	Color Temp	Lumen	Color
CL-VL-1327L-24W-5CCT-BL	100-277VAC	24W	5CCT Adjustable 2700K-3000K	70lm/W	Black
CL-VL-1327L-24W-5CCT-GL			3500K-4000K-5000K		Gold

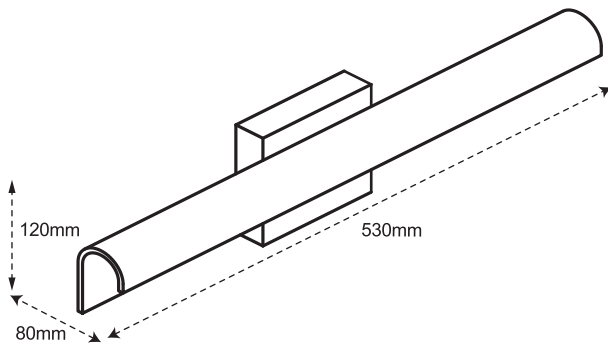

- Isolated flicker free driver
- OSRAM LED
- cETL certificate



LED Strip Lights

cano light
Canadian Brightness

Low Voltage Neon Strip Lights

307A-Side Bend

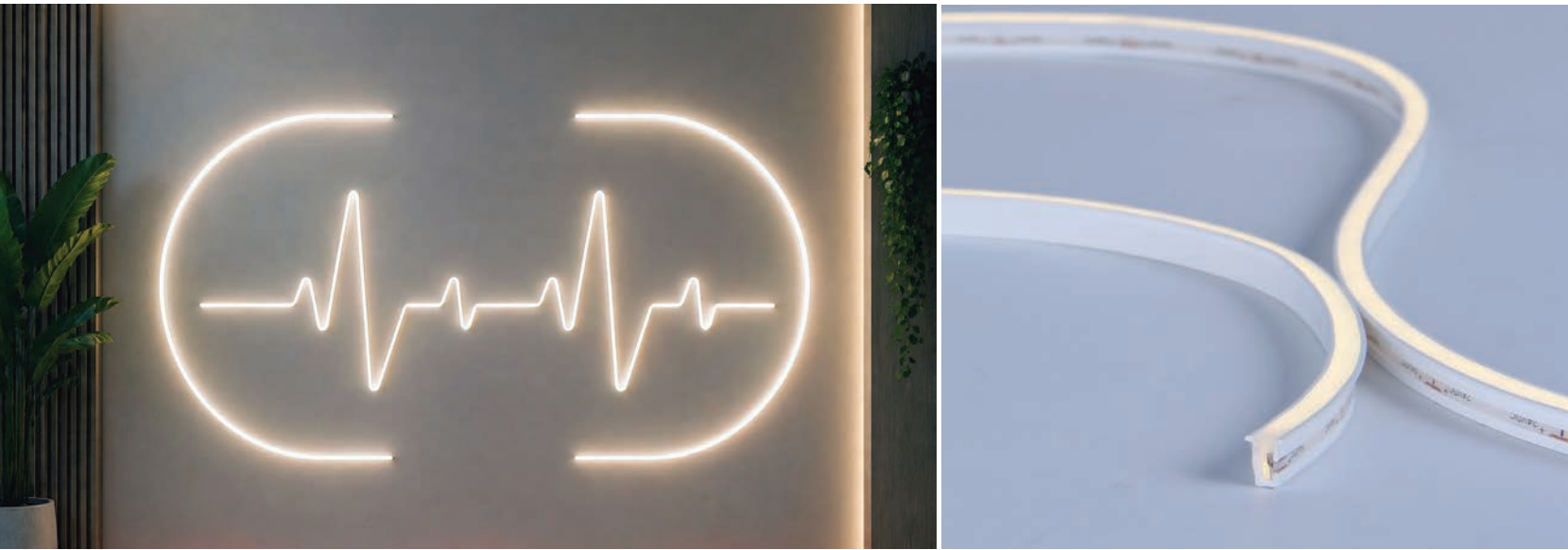

Product Code	IN Voltage	Power	Lumen	Color Temp	Reel
CL-ST-NEON0307A-LR-4-3K	24VDC	4W/m	25lm/W	3000K	5m/Roll
CL-ST-NEON0307A-LR-4-4K				4000K	5m/Roll
CL-ST10-NEON0307A-LR-4-3K	24VDC	4W/m	25lm/W	3000K	10m/Roll
CL-ST10-NEON0307A-LR-4-4K				4000K	10m/Roll

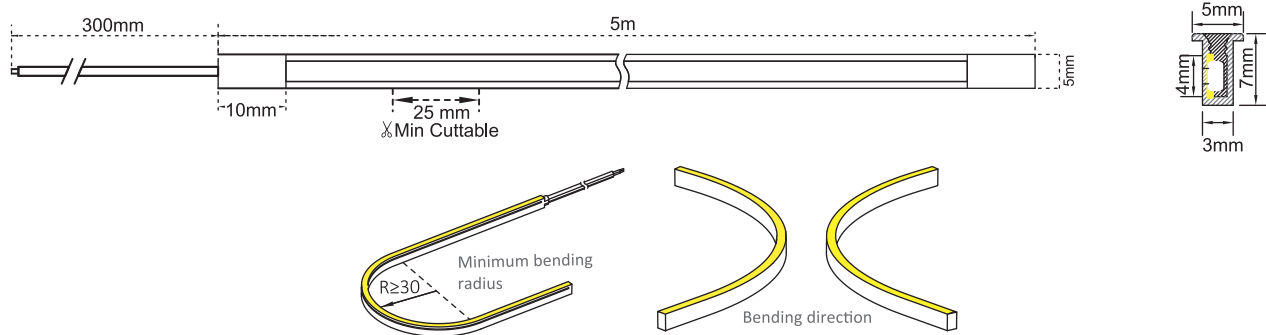

Accessories

CL-ACC-NEON0307A-ECH
End cap with hole

CL-ACC-NEON0307A-EC
End cap without hole

CL-ACC-NEON0307A-ALU-1M
Mounting Aluminum Profile-Silver

CL-ACC-NEON0307A-Clips
Installation Clips

- Maximum 10 meters of neon strips can be connected in series mode to one power supply.
- cUL approved



Low Voltage Neon Strip Lights

407-Side Bend



Product Code	IN Voltage	Power	Lumen	Color Temp	Reel
CL-ST-NEON0407-LR-7.2-3K	24VDC	7.2W/m	50lm/W	3000K	5m/Roll
CL-ST-NEON0407-LR-7.2-4K				4000K	5m/Roll
CL-ST10-NEON0407-LR-7.2-3K	24VDC	7.2W/m	50lm/W	3000K	10m/Roll
CL-ST10-NEON0407-LR-7.2-4K				4000K	10m/Roll

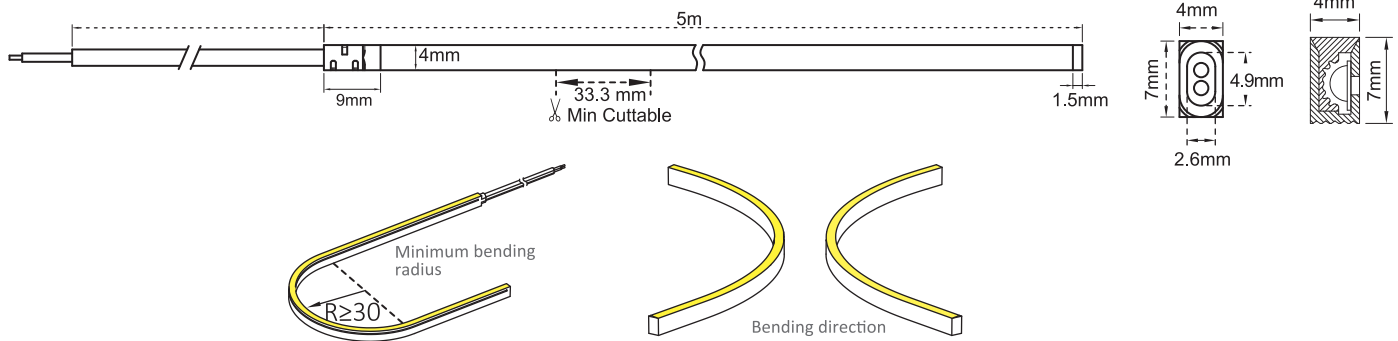

Accessories

CL-ACC-NEON0407-ECH
End cap with hole

CL-ACC-NEON0407-EC
End cap without hole

CL-ACC-NEON0407-ALU-1M
Mounting Aluminum Profile-Silver

CL-ACC-NEON0407-Clips
Installation Clips

CL-ACC-NEON0407-SSP-1M
Stainless steel bendable profile

- Maximum 10 meters of neon strips can be connected in series mode to one power supply.
- cUL approved



Low Voltage Neon Strip Lights

606-Top Bend



Product Code	IN Voltage	Power	Lumen	Color Temp	Reel
CL-ST-NEON0606-UD-7.2-3K	24VDC	7.2W/m	80lm/W	3000K	5m/Roll
CL-ST-NEON0606-UD-7.2-4K				4000K	5m/Roll
CL-ST10-NEON0606-UD-7.2-3K	24VDC	7.2W/m	80lm/W	3000K	10m/Roll
CL-ST10-NEON0606-UD-7.2-4K				4000K	10m/Roll

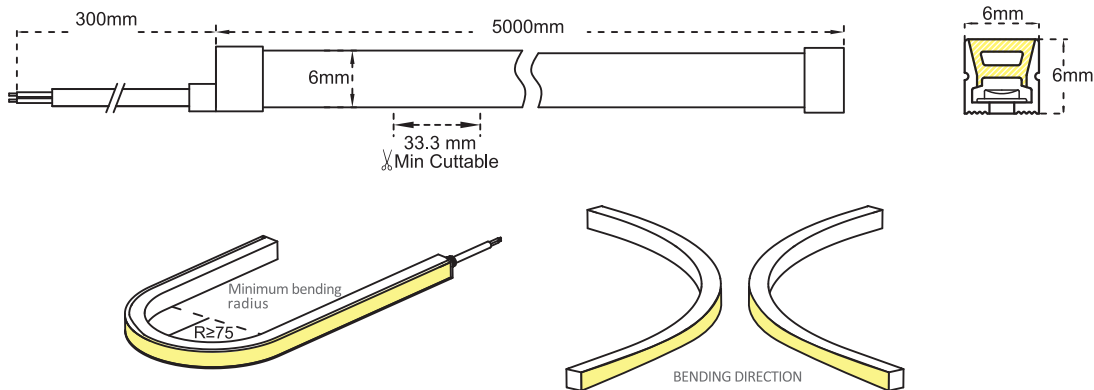

Accessories

CL-ACC-NEON0606-ECH
End cap with hole

CL-ACC-NEON0606-EC
End cap without hole

CL-ACC-NEON0606-ALU-1M
Mounting Aluminum Profile-Silver

CL-ACC-NEON0606-Clips
Installation Clips

CL-ACC-NEON0606-SSP-1M
Stainless steel bendable profile

- Maximum 10 meters of neon strips can be connected in series mode to one power supply.
- cUL approved



Low Voltage Neon Strip Lights

608A-Top Bend



Product Code	IN Voltage	Power	Lumen	Color Temp	Reel
CL-ST-NEON0608A-UD-4-3K	24VDC	4W/m	80lm/W	3000K	5m/Roll
CL-ST-NEON0608A-UD-4-4K				4000K	5m/Roll
CL-ST10-NEON0608A-UD-4-3K	24VDC	4W/m	80lm/W	3000K	10m/Roll
CL-ST10-NEON0608A-UD-4-4K				4000K	10m/Roll

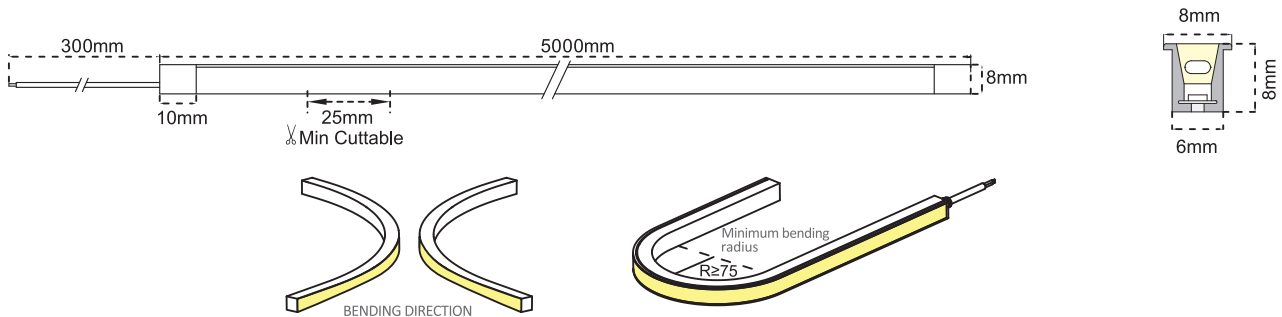

Accessories

CL-ACC-NEON0608-ECH
End cap with hole

CL-ACC-NEON0608-EC
End cap without hole

CL-ACC-NEON0608-ALU-1M
Mounting Aluminum Profile-Silver

CL-ACC-NEON0608-Clips
Installation Clips

- Maximum 10 meters of neon strips can be connected in series mode to one power supply.
- cUL approved



Low Voltage Neon Strip Lights

1208-3D Bendable



Product Code	IN Voltage	Power	Lumen	Color Temp	Reel
CL-ST-NEON1208-3D-14.4-3K	24VDC	14.4W/m	60lm/W	3000K	5m/Roll
CL-ST-NEON1208-3D-14.4-4K				4000K	5m/Roll
CL-ST10-NEON1208-3D-14.4-3K	24VDC	14.4W/m	60lm/W	3000K	10m/Roll
CL-ST10-NEON1208-3D-14.4-4K				4000K	10m/Roll

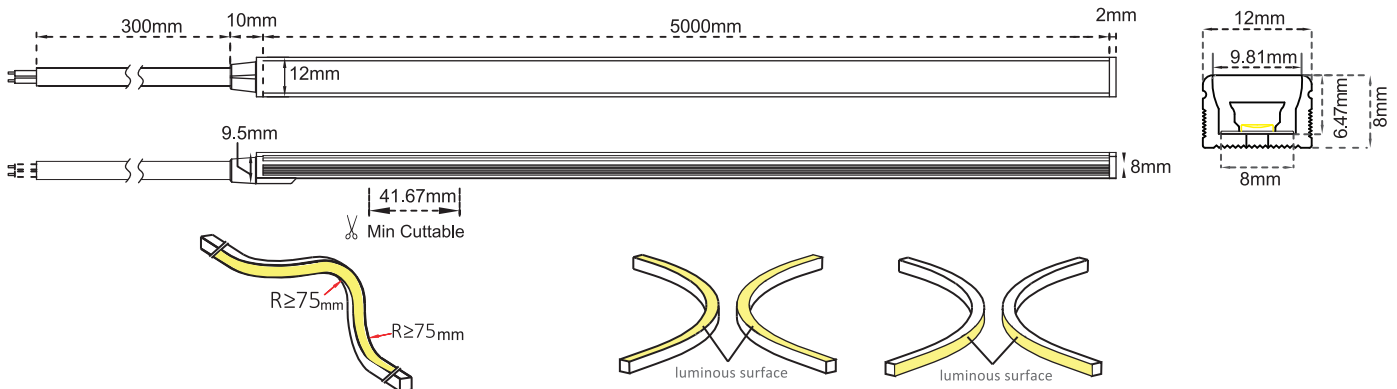

Accessories

CL-ACC-NEON1208-ECH
End cap with hole

CL-ACC-NEON1208-EC
End cap without hole

CL-ACC-NEON1208-ALU-1M
Mounting Aluminum Profile-Silver

CL-ACC-NEON1208-Clips
Installation Clips

CL-ACC-NEON1208-SSP-1M
Stainless steel bendable profile

- Maximum 10 meters of neon strips can be connected in series mode to one power supply.
- cUL approved



Low Voltage Neon Strip Lights

1212-3D Bendable



Product Code	IN Voltage	Power	Lumen	Color Temp	Reel
CL-ST-NEON1212-3D-14.4-3K	24VDC	14.4W/m	70lm/W	3000K	5m/Roll
CL-ST-NEON1212-3D-14.4-4K				4000K	5m/Roll
CL-ST10-NEON1212-3D-14.4-3K	24VDC	14.4W/m	70lm/W	3000K	10m/Roll
CL-ST10-NEON1212-3D-14.4-4K				4000K	10m/Roll

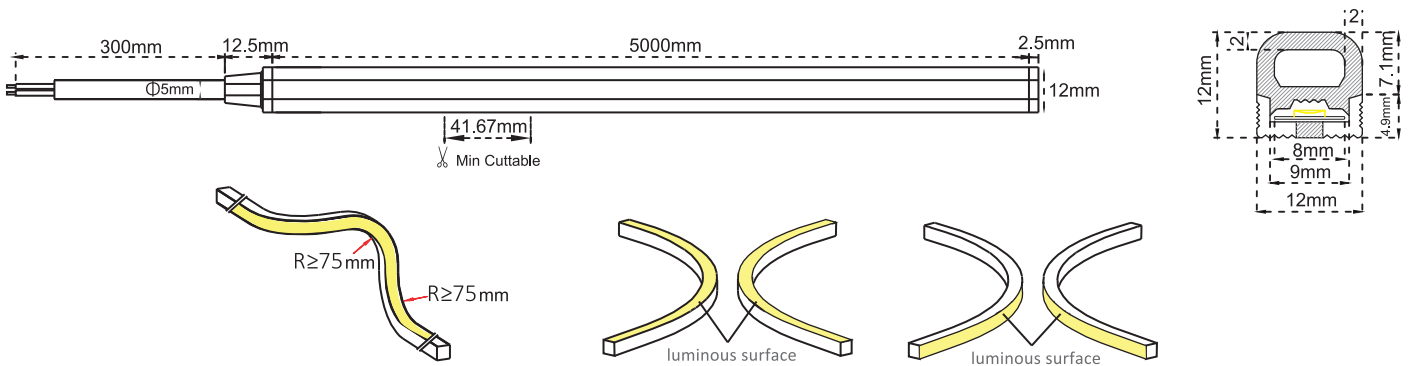

Accessories

CL-ACC-NEON1212-ECH
End cap with hole

CL-ACC-NEON1212-EC
End cap without hole

CL-ACC-NEON1212-ALU-1M
Mounting Aluminum Profile-Silver

CL-ACC-NEON1212-Clips
Installation Clips

- Maximum 10 meters of neon strips can be connected in series mode to one power supply.
- cUL approved



Low Voltage Neon Strip Lights

1515-3D Bendable



Product Code	IN Voltage	Power	Lumen	Color Temp	PCB Width	Reel
CL-ST-NEON1515-3D-13-3K	24VDC	13W/m	60lm/W	3000K	8mm	5m/Roll
CL-ST-NEON1515-3D-13-4K				4000K		
CL-ST10-NEON1515-3D-13-3K	24VDC	13W/m	60lm/W	3000K	8mm	10m/Roll
CL-ST10-NEON1515-3D-13-4K				4000K		

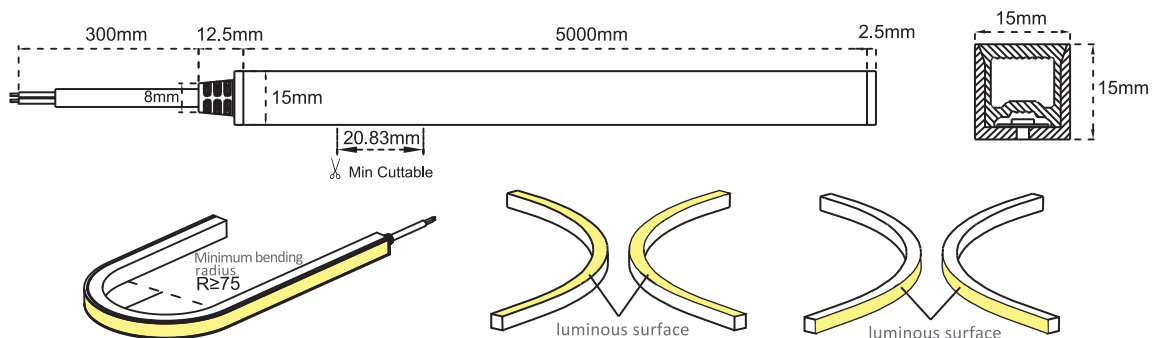

Accessories

CL-ACC-NEON1515-ECH
End cap with hole

CL-ACC-NEON1515EC
End cap without hole

CL-ACC-NEON1515-ALU-1M
Mounting Aluminum Profile-Silver

CL-ACC-NEON1515-Clips
Installation Clips

CL-ACC-NEON1515-SSP-1M
Stainless steel bendable profile

- Maximum 10 meters of neon strips can be connected in series mode to one power supply.
- cUL approved



Low Voltage Neon Strip Lights

1515 RGB-3D Bendable



Product Code	IN Voltage	Power	Color Temp	Reel
CL-ST-NEON1515-3D-14.4-RGB	24VDC	14.4W/m	RGB	5m/Reel
CL-ST10-NEON1515-3D-14.4-RGB	24VDC	14.4W/m	RGB	10m/Reel

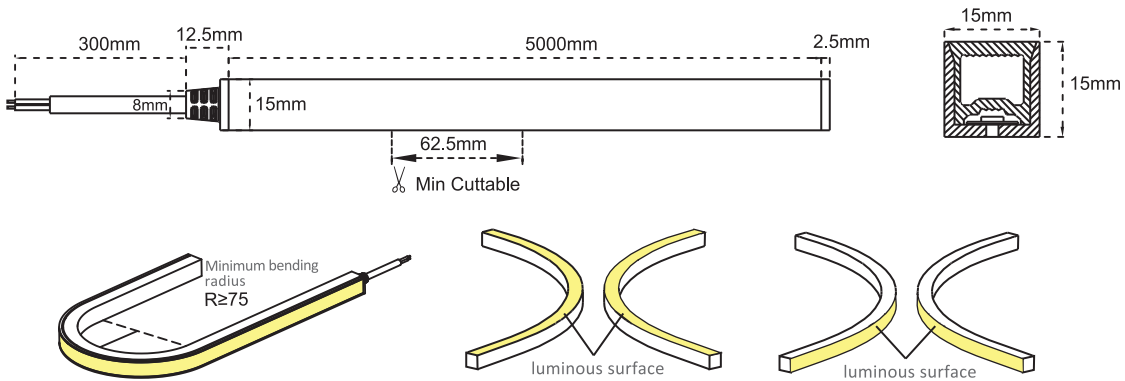

Accessories

CL-ACC-NEON1515-ECH
End cap with hole

CL-ACC-NEON1515EC
End cap without hole

CL-ACC-NEON1515-ALU-1M
Mounting Aluminum Profile-Silver

CL-ACC-NEON1515-Clips
Installation Clips

CL-ACC-NEON1515-SSP-1M
Stainless steel bendable profile

- Maximum 10 meters of neon strips can be connected in series mode to one power supply.
- cUL approved



Low Voltage 360° Neon Strip Lights

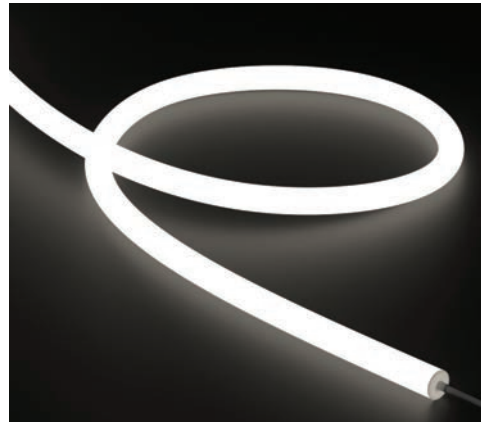

Product Code	Input Voltage	Power	Lumen	Color Temp	Diameter	Reel
CL-STNEON25-360D-2465-3K	24VDC	14.4W/m	930lm/m	3000K	Φ25mm	5m/Roll
CL-STNEON25-360D-2465-4K				4000K		

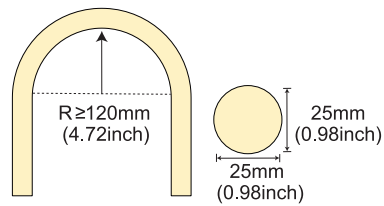
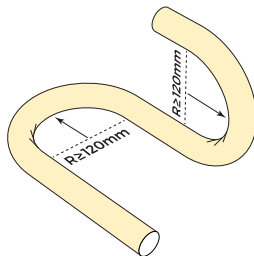

Bending Direction & Min. radius

DC
24V

subject to appropriate power supply
DIMMABLE

CRI
>90

IP65

WARRANTY
5
YEARS

Lifetime
>50,000 hrs

Working Temperature

• cUL approved

Neon 360° Strip Lights Installation Accessories

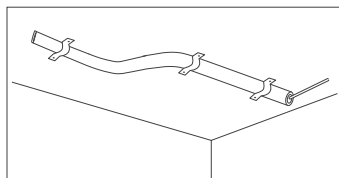

CL-ST-NEON25-360D-Clips kit A
Material: PC, Transparent
Size: L25 x W51.6 x H27.8 mm

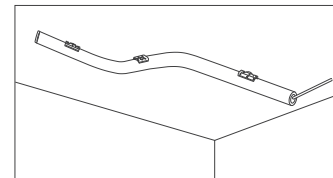

CL-ST-NEON25-360D-Clips kit B
Concealed buckle/Steel needle/Clip

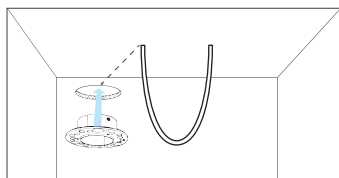

CL-ST-NEON25-360D-Embedded kit trimless
Size: $\Phi 64 \times H20\text{mm}$
Mounting hole size: $\Phi 40\text{mm}$

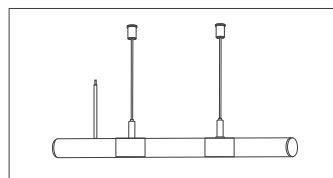

CL-ST-NEON25-360D-Horizontal pendant kit
Transparent
Size: $\Phi 30 \times H80\text{mm}$

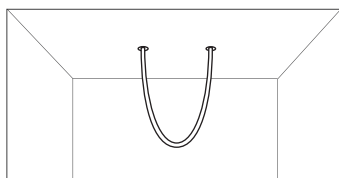

CL-ST-NEON25-360D-Embedded kit with trim
Size: $\Phi 64 \times H20 \text{ mm}$
Mounting hole size: $\Phi 40\text{mm}$

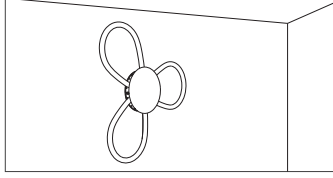

CL-ST-NEON25-360D-Wall mount clip C-BL
Wall mount clip C
Size: Outer $\Phi 110 \times$ inner $\Phi 90 \times H30\text{mm}$

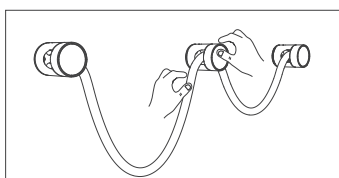

CL-ST-NEON25-360D-Wall mount clip A
Cylindrical wall mount clip
Size: $\Phi 33\text{mm} \times H44\text{mm}$

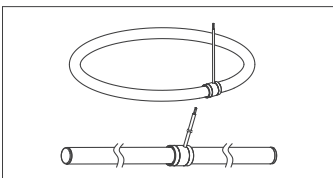

CL-ST-NEON25-360D-Mounting kit
Connecting ring/Connector/screws/wirerope

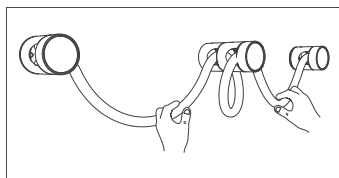

CL-ST-NEON25-360D-Wall mount clip B
Cylindrical wall mount clip
Size: $\Phi 33\text{mm} \times H76\text{mm}$

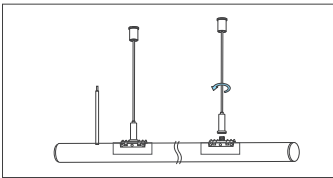

CL-ST-NEON25-360D-Horizontal lifting kit
PC tube length: 38mm
Length of wire rope: 2m

Neon 360° Strip Lights Installation Accessories

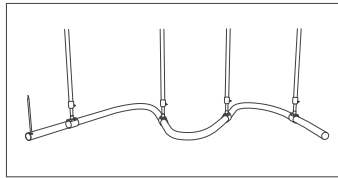

CL-ST-NEON25-360D-Vertical lifting kit A

Round tube Size: L38x ϕ 29.4mm

Telescopic pole length: 0.3-0.6m

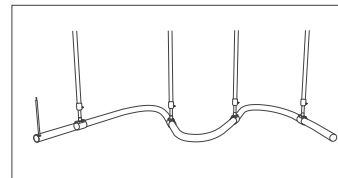

CL-ST-NEON25-360D-Vertical lifting kit B

Round tube Size: L38x ϕ 29.4mm

Telescopic pole length: 0.3-0.6m

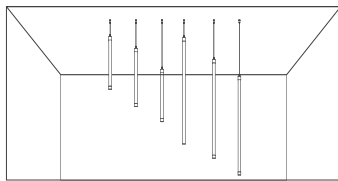

CL-ST-NEON25-360D-single end vertical surface mount kit B

Lifting plug\ round tube\ Metal plug\2m wire rope

Round tube size: L1000 x ϕ 29.4mm

Wire rope length: ϕ 3 x 2000mm, 20AWG

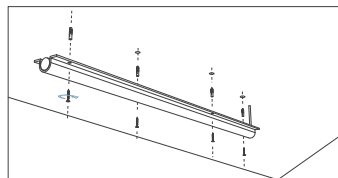

CL-ST-NEON25-360D-Horizontal surface mount kit

Horizontal ceiling installation accessory package

PC tube length: 1m

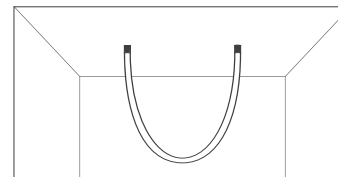

CL-ST-NEON25-360D-Double end vertical pendant kit

Double end vertical ceiling installation accessory

Included: pendant end cap/screws/plug



Low Voltage Tunable COB Strip Lights

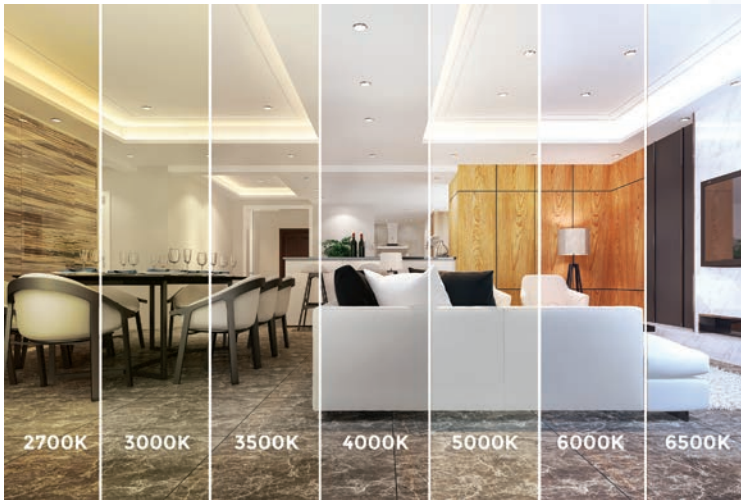

Product Code	IN Voltage	Power	Lumen	Color Temp	LED QTY	PCB Width	Reel
CL-ST-COB-608-14-2420-TW	24VDC	14W/m	90lm/W	Tunable	608LED/M	10mm	5m/Roll
CL-ST10-COB-608-14-2420-TW				2700K to 6500K			10m/Roll

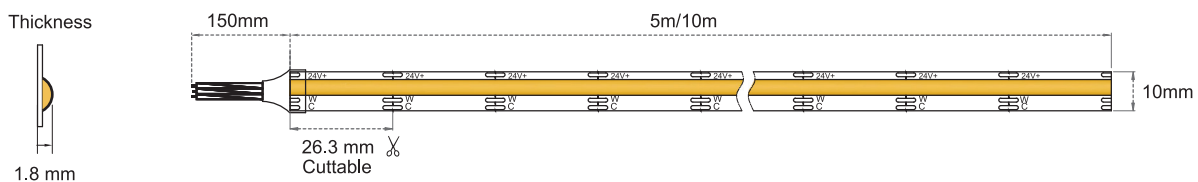

- Installation accessories are available.
- Maximum 10 meters of strips can be connected in series mode to one power supply.
- cUL approved
- A tunable white compatible controller is required for color temperature control.
Compatible Canolight RGBCW controllers and remotes:
 - CL-AST-SWCWL5-LV
 - CX-W01-P5-12A-RGBCW controller
 - CL-AST-RFCLS2-LV
 - CL-AST-RFRFUT092-LV

Subject to appropriate power fixtures

DIMMABLE

DC 24V

32ft 10m /roll

16ft 5m /roll

CRI > 90

IP20

DRY LOCATION

3 YEARS WARRANTY

Lifetime > 50,000 hrs

Working Temperature -25°C to +50°C

High Quality 3M Back Adhesive

Low-Voltage COB LED Strip Lights



IP20 **IP65**

Input Voltage	Power	Lumen	LED Qty	CRI	Reel	PCB Width
24VDC	9W/m	750lm/m	480LED/m	>90	16 ft (5m)	8 mm

	Product Code	Color Temp
IP20	CL-ST-COB-480-9-2420-2.7K	2700K
	CL-ST-COB-480-9-2420-3K	3000K
	CL-ST-COB-480-9-2420-3.5K	3500K
	CL-ST-COB-480-9-2420-4K	4000K
	CL-ST-COB-480-9-2420-5K	5000K
IP65	CL-ST-COB-480-9-2465-3K	3000K
	CL-ST-COB-480-9-2465-4K	4000K
	CL-ST-COB-480-9-2465-5K	5000K

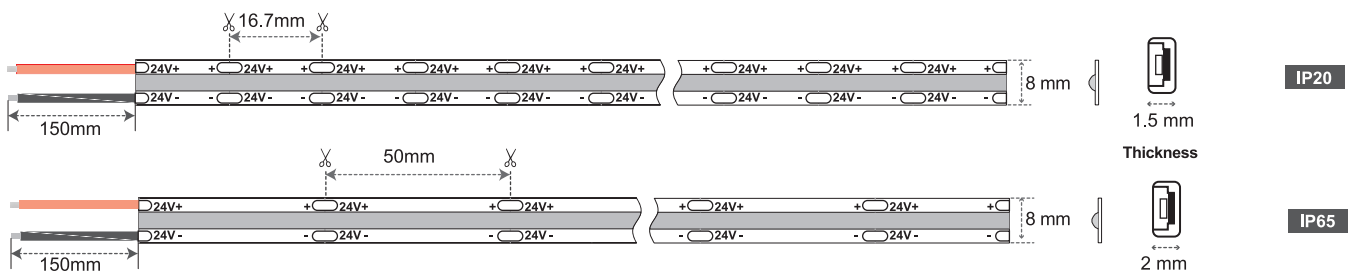
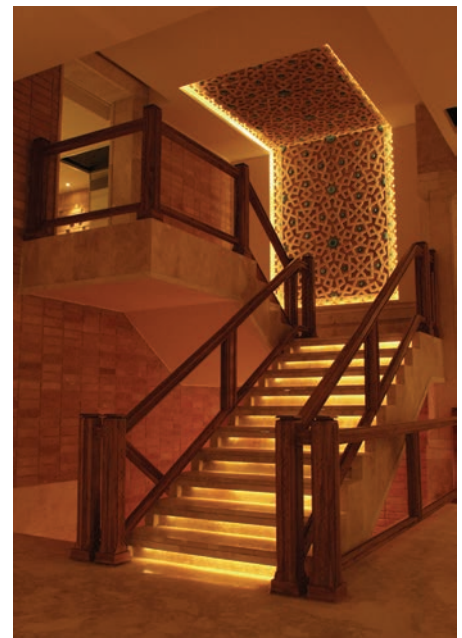

-
-
-
-
-
-
-

- Installation accessories are available.
- Maximum 10 meters of strips can be connected in series mode to one power supply.
- 24V strip, superior performance compared to 12V strip
- cUL approved
- Uniform and dotless light effect

Low-Voltage Long-Run COB LED Strip Lights



Input Voltage	Power	Lumen	LED Qty	CRI	Reel	PCB Width
24VDC	8W/m	640lm/m	384LED/m	>90	32 ft (10m)	8 mm

	Product Code	Color Temp
IP20	CL-ST10-COB-384-8-2420-2.7K	2700K
	CL-ST10-COB-384-8-2420-3K	3000K
	CL-ST10-COB-384-8-2420-3.5K	3500K
	CL-ST10-COB-384-8-2420-4K	4000K
	CL-ST10-COB-384-8-2420-5K	5000K
IP67	CL-ST10-COB-384-8-2467-3K	3000K
	CL-ST10-COB-384-8-2467-4K	4000K
	CL-ST10-COB-384-8-2467-5K	5000K

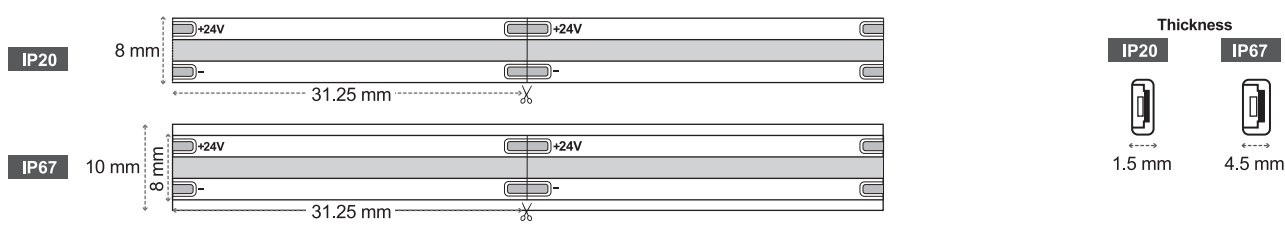

DIMMABLE (subject to appropriate power supply)
 3 YEARS WARRANTY
 Lifetime >50,000 hrs
 Working Temperature: -25°C to +50°C
 High Quality 3M Back Adhesive
 32ft 10m /roll

- Installation accessories are available.
- Maximum 10 meters of strips can be connected in series mode to one power supply.
- 24V strip, superior performance compared to 12V strip
- cUL approved
- Uniform and dotless light effect

Low-Voltage COB LED Strip Lights RGB, RGBW

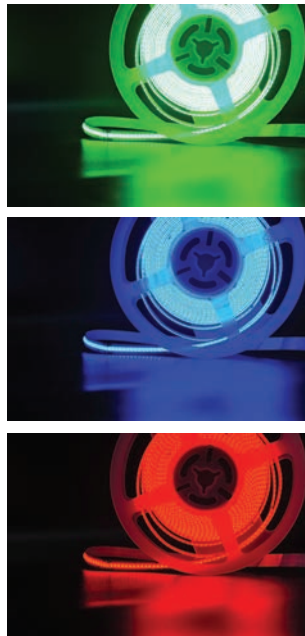

CL-ST-COB-630-9-2420-RGB



CL-ST-COB-896-16-2420-RGBW

Product Code	IN Voltage	Power	CCT	Lumen	IP	Reel	PCB Width
CL-ST-COB-630-9-2420-RGB	24VDC	9W/m	RGB	630LED/m	20	16 ft (5 m)	10 mm
CL-ST10-COB-630-9-2420-RGB	24VDC	9W/m	RGB	630LED/m	20	32 ft (10m)	10 mm
CL-ST-COB-630-9-2467-RGB	24VDC	9W/m	RGB	630LED/m	67	16 ft (5 m)	10 mm
CL-ST-COB-896-16-2420-RGBW	24VDC	16W/m	RGBW White color is 3K	896LED/m	20	16 ft (5 m)	12 mm
CL-ST10-COB-896-16-2420-RGBW	24VDC	16W/m	RGBW White color is 3K	896LED/m	20	32 ft (10m)	12 mm

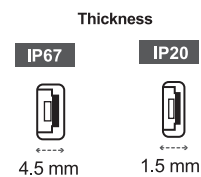
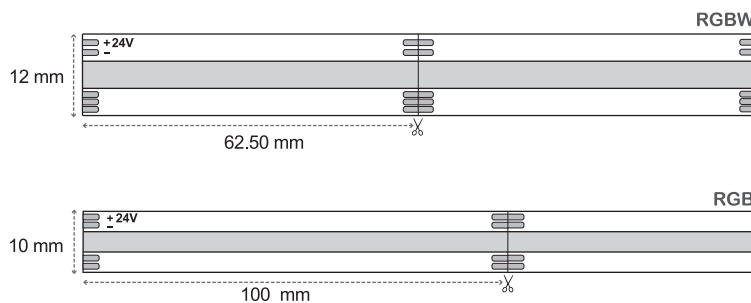

- Installation accessories are available.
- Maximum 10 meters of strips can be connected in series mode to one power supply.
- 24V strip, superior performance compared to 12V strip
- cETL or cUL approved
- Uniform and dotless light effect

Low-Voltage SOB LED Strip Light

High Performance Dotted Strip Lights



Input Voltage	Power	Lumen	LED QTY	IP	PCB Width
24VDC	9.6W/m	1300lm/m	288LED/m	40	8 mm

Product Code	Color Temp	Product Code	Color Temp
CL-ST-SOB-288-9.6-2440-2.7K	2700K	CL-ST10-SOB-288-9.6-2440-2.7K	2700K
CL-ST-SOB-288-9.6-2440-3K	3000K	CL-ST10-SOB-288-9.6-2440-3K	3000K
CL-ST-SOB-288-9.6-2440-3.5K	3500K	CL-ST10-SOB-288-9.6-2440-3.5K	3500K
CL-ST-SOB-288-9.6-2440-4K	4000K	CL-ST10-SOB-288-9.6-2440-4K	4000K
CL-ST-SOB-288-9.6-2440-5K	5000K	CL-ST10-SOB-288-9.6-2440-5K	5000K

16ft

32ft

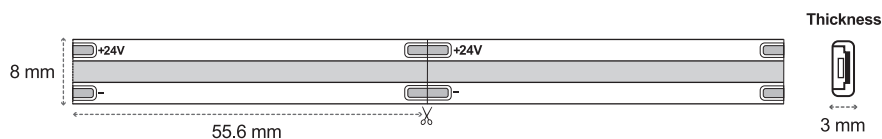

- Installation accessories are available.
- Maximum 10 meters of strips can be connected in series mode to one power supply.
- Up to 2 times more brighter than COB strip lights
- Better lumen maintenance and longer lifetime.
- 24V strip, superior performance compared to 12V strip
- cUL approved
- Uniform and dotless light effect

Low-Voltage CSP LED Strip Lights



Product Code	Input Voltage	Power	LED QTY	Lumen	Color Temp	IP	PCB Width
CL-ST-CSP-320-10-2468-3K	24VDC	10 W/m	320 LED/m	950 lm/m	3000K	68	8 mm
CL-ST-CSP-320-10-2468-4K					4000K		
CL-ST-CSP-320-10-2468-5K					5000K		

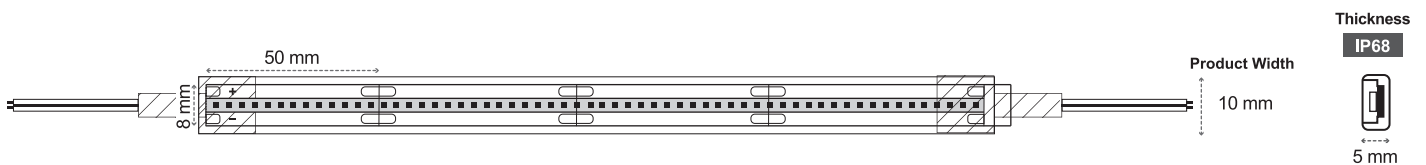

- Installation accessories are available.
- Maximum 10 meters of strips can be connected in series mode to one power supply.
- Suitable for sauna and underwater
- 24V strip, superior performance compared to 12V strip
- cUL approved

Low-Voltage COB Mini LED Strip Lights



Product Code	Input Voltage	Power	LED QTY	Lumen	Color Temp	IP
CL-STMINI-COB-504-6-2420-3K					3000K	
CL-STMINI-COB-504-6-2420-4K	24 VDC	6 W/m	504 LED/m	480lm/m	4000K	20
CL-STMINI-COB-504-6-2420-5K					5000K	

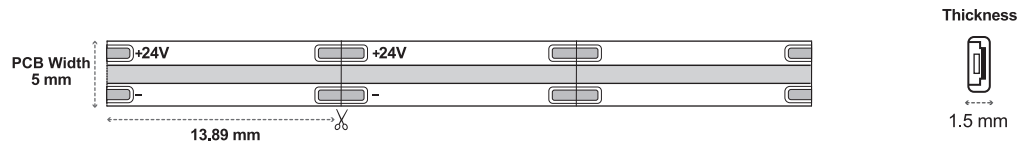

- Installation accessories are available.
- Maximum 10 meters of strips can be connected in series mode to one power supply.
- 24V strip, superior performance compared to 12V strip
- cETL or cUL approved
- Uniform and dotless light effect



Low Voltage COB Chaseable Strip Lights



Product Code	Input Voltage	Power	Lumen	Color Temp	LED QTY	PCB Width
CL-STCHASE-COB-420-13-2420-3K	24 VDC	13W/m	1040lm/m	3000K	420LED/m	12 mm
CL-STCHASE-COB-420-13-2420-4K				4000K		

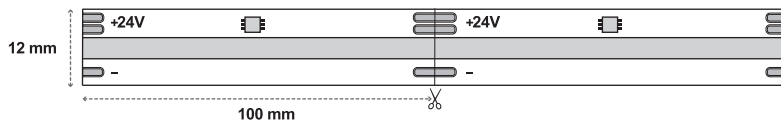

- Compatible Canolight controller: CL-AST-RFCSPI01-LV and Remote: CL-AST-RFRRFBK-LV
- Installation accessories are available.
- Maximum 10 meters of strips can be connected in series mode to one power supply.
- Uniform and dotless light effect
- 24V strip, superior performance compared to 12V strip
- cUL approved

subject to appropriate power systems

DIMMABLE

DC 24V

CRI > 90

IP20

5 YEARS WARRANTY

Lifetime > 50,000 hrs

Working Temperature

16ft 5m /roll

High Quality 3M Back Adhesive

Low Voltage High-Lumen SMD Strip Lights



Product Code	Input Voltage	Power	Lumen	Color Temp	LED QTY	PCB Width
CL-STHL-SMD-240-21.6-2420-3K	24VDC	21.6W/m	2,592lm/m	3000K	240LED/m	12 mm
CL-STHL-SMD-240-21.6-2420-4K	24VDC	21.6W/m	2,592lm/m	4000K	240LED/m	12 mm

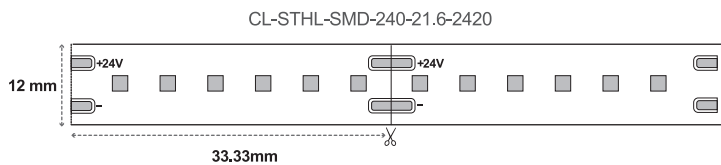

- Installation accessories are available.
- Maximum 10 meters of strips can be connected in series mode to one power supply.
- 24V strip, superior performance compared to 12V strip
- cUL approved

Low Voltage High-Lumen SMD Strip Lights



Product Code	Input Voltage	Power	Lumen	CCT	LED QTY	IP	PCB Width
CL-STHL-SMD-240-14.4-2420-3K	24 VDC	14.4W/m	1,770lm/m	3000K	240 LED/m	20	8 mm
CL-STHL-SMD-240-14.4-2420-4K	24 VDC	14.4W/m	1,900lm/m	4000K	240 LED/m	20	8 mm
CL-STHL-SMD-240-14.4-2420-5K	24 VDC	14.4W/m	1,950lm/m	5000K	240 LED/m	20	8 mm

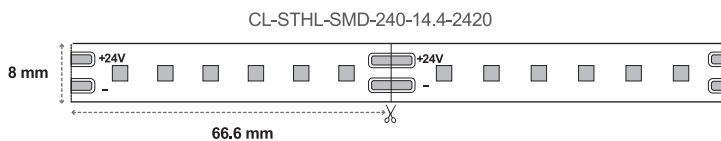

- Installation accessories are available.
- Maximum 10 meters of strips can be connected in series mode to one power supply.
- 24V strip, superior performance compared to 12V strip
- cUL approved



LED Wall Washer Strip Lights

cano light
Canadian Brightness

Low Voltage Wall Washer Strip Lights



Product Code	Input Voltage	Power	Lumen	Color Temp	Beam Angle	Roll
CL-STW1-SMD-56-14-2467-30D-3K	24 VDC	14.4W/m	1260lm/m	3000K	30°	5m/Roll
CL-STW1-SMD-56-14-2467-30D-4K	24 VDC	14.4W/m	1260lm/m	4000K	30°	5m/Roll
CL-STW1-SMD-56-14-2467-30D-5K	24 VDC	14.4W/m	1260lm/m	5000K	30°	5m/Roll

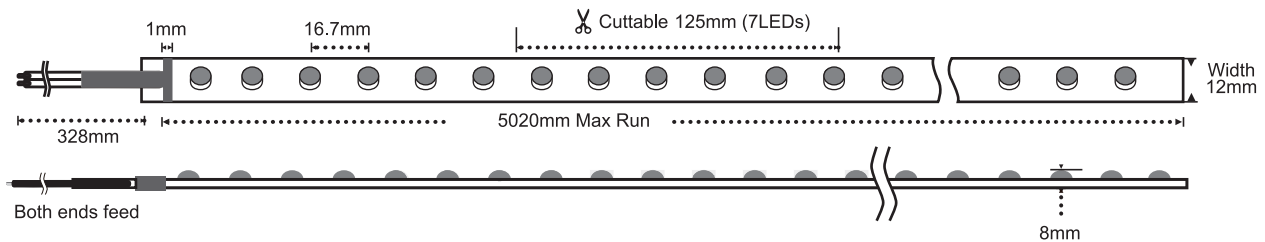

Accessories

CL-STW1-CLIPS
Clips
Dimensions: 14x9.5x30mm

CL-STW1-ALU
Aluminum Profiles
Dimensions: 14x9.5x1000mm

CL-STW1-EC
End Cap without hole

CL-STW1-ECH
End Cap with hole

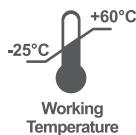

Accessories included:
15 pcs of clips, 4 pcs of end caps with holes and 4 pcs of end caps without holes

- SMD2835
- cUL listed

Low Voltage RGBW Wall Washer Strip Light

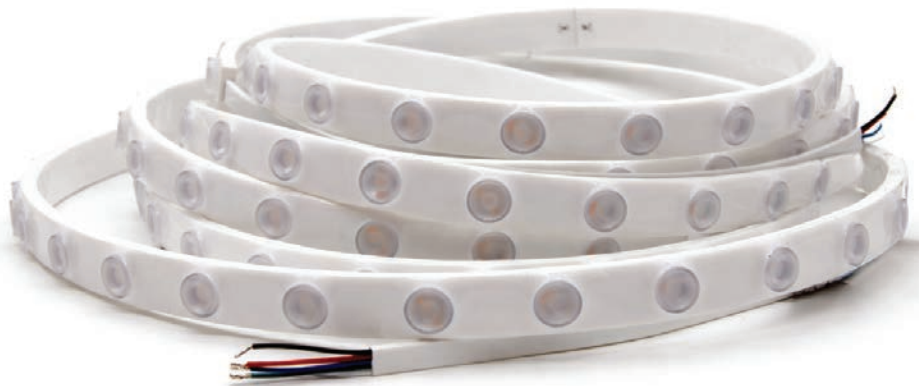
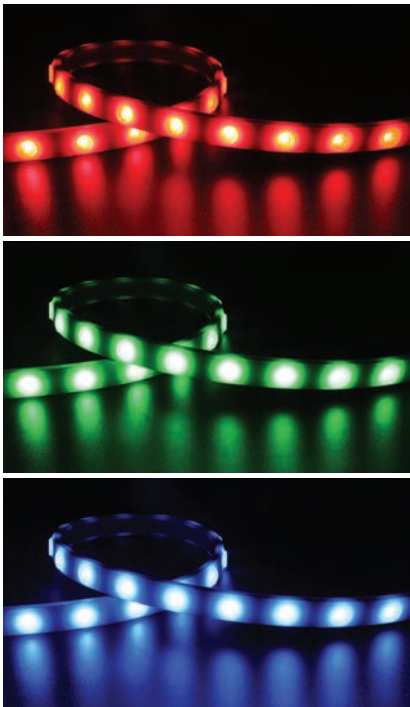

Product Code	Input Voltage	Power	Lumen	Color Temp	Beam Angle	Roll
CL-STW2-SMD-28-2467-30D-RGBW	24 VDC	24W/m	570lm/m White	RGBW	30°	5m/Roll

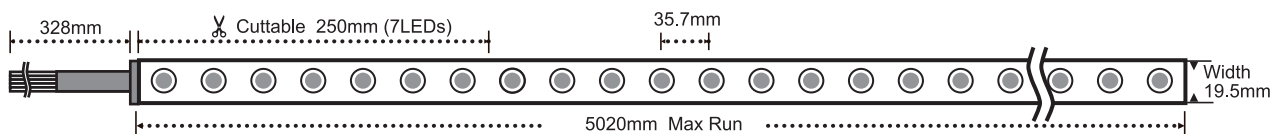

Accessories

CL-STW2-CLIPS
Clips
Dimensions: 21.9 x 10.9 x 35mm

CL-STW2-MOUNTING CLIPS
Adjustable Mounting Clip

CL-STW2-EC
End Cap without hole

CL-STW2-ECH
End Cap with hole

CL-STW2-ALU
Aluminum Profiles
Dimensions: 21.9 x 10.9 x 1000mm



Accessories included:
15 pcs of clips, 4 pcs of end caps with holes and 4 pcs of end caps without holes

- SMD5050
- cUL listed

High-Voltage SMD LED Strip Lights



Product Code	Input Voltage	Power	Lumen	CCT	LED QTY	IP
CL-ST-SMD-2835-60-6-11065-3K	110-120 VAC 50/60Hz	6W/m	250lm/m	3000K	60LED/m	65
CL-ST-SMD-2835-60-6-11065-4K	110-120 VAC 50/60Hz	6W/m	250lm/m	4000K	60LED/m	65
CL-ST-SMD-5050-60-8-11065-RGB	110-120 VAC 50/60Hz	8W/m		RGB	60LED/m	65

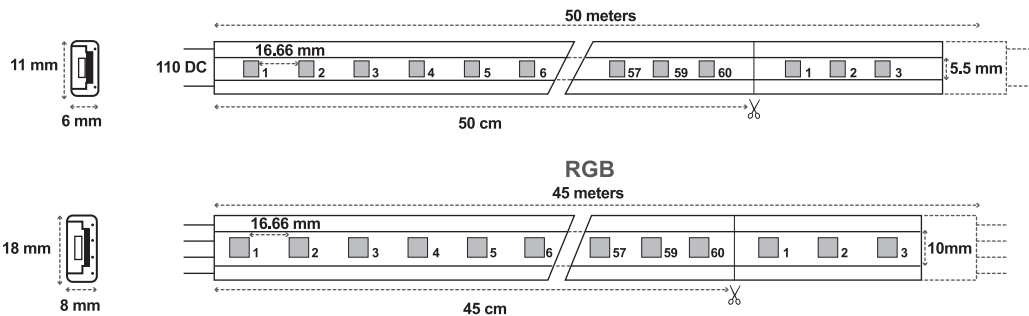

- o Installation accessories are available.
- o Each roll includes 2 middle connectors, 2 endcaps, 4 installation clips, and 1 power cord
- SMD 2835 is Triac dimmable
- Easy installation
- 50 m/roll in 2835 strips
- 45 m/roll in 5050 strips
- One rectifier can run one roll of strips
- Unique white PVC cover outlook
- cETL certificate



High Voltage 360° LED Strip Lights



Product Code	Input Voltage	Power	Lumen	CCT	IP
CL-ST-360-7-11065-3K	110-120 VAC 50/60Hz	7W/m	60lm/W	3000K	65
CL-ST-360-7-11065-4K	110-120 VAC 50/60Hz	7W/m	60lm/W	4000K	65
CL-ST-360-7-11065-5K	110-120 VAC 50/60Hz	7W/m	60lm/W	5000K	65

Installation Accessories

- CL-ST-360-11065-Clips
- CL-ST-360-11065-End cap
- CL-ST-360-11065-L connector
- CL-ST-360-11065-Middle connector
- CL-ST-360-11065-Rectifier



- o Each roll includes 30 meters of strip light, one rectifier, 5pcs end caps, 20pcs clips, 40 pcs screws
- Diameter 13mm
- 2835 SMD LED - 144 pcs/m
- Length: 30m/Roll (98.43ft)
- Cutting size: 50cm
- cETL certificate

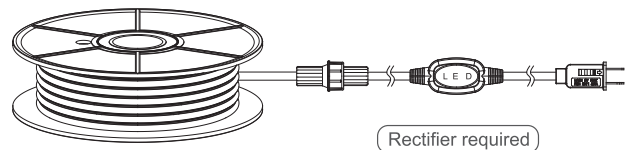

High Voltage 180° Dotless LED Strip Lights



Product Code	IN Voltage	Power	Lumen	CCT	IP
CL-ST-180-10-11065-3K	110-120VAC 50/60Hz	10W/m	700lm/m	3000K	65
CL-ST-180-10-11065-4K	110-120VAC 50/60Hz	10W/m	700lm/m	4000K	65
CL-ST-180-10-11065-5K	110-120VAC 50/60Hz	10W/m	700lm/m	5000K	65

Installation Accessories

CL-ST-180-11065-plug
1.5 meter plug with female connector

CL-ST-180-11065-middle connector
PCB to PCB no wire

CL-ST-180-11065-middle connector wire
PCB to PCB with wire

CL-ST-180-11065-clips

CL-ST-180-11065-end cap

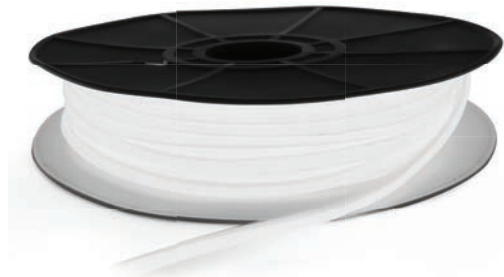

- Each roll includes 30 meters of strip light, 1.5m plug, 5pcs end caps, 20pcs clips, 40 pcs screws
- SMD2025 - 260 pcs/m
- Length: 30m/Roll (98.43ft)
- Cutting size: 5cm
- cETL certificate

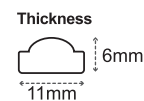



Aluminum Profiles

cano light
Canadian Brightness

Aluminum Profiles

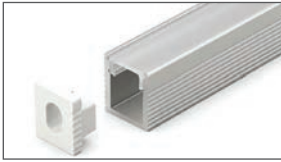

CL-Alu-0809-SL



CL-Alu-0809-BL (With Black and White PC Cover)

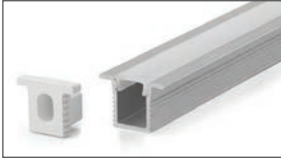
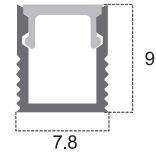
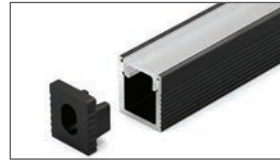

CL-Alu-0809A SL



CL-Alu-0809A-BL (With Black and White PC Cover)

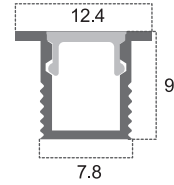

CL-Alu-510-SL
Available in 8ft and 10ft lengths

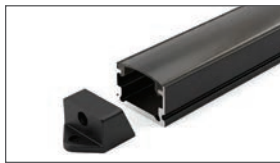

CL-Alu-510-BL (With Black and White PC Cover)
Available in 8ft and 10ft lengths

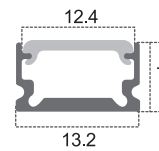
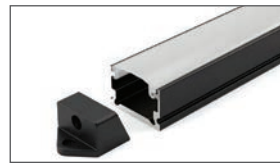

CL-Alu-510A-SL



CL-Alu-510A-BL (With Black and White PC Cover)

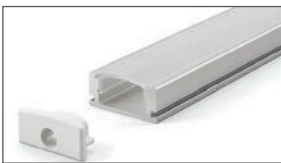
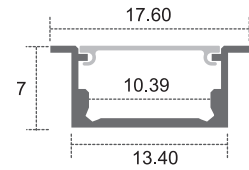

CL-Alu-509-SL
Available in 8ft and 10ft lengths



CL-Alu-509-BL (With Black and White PC Cover)
Available in 8ft and 10ft lengths

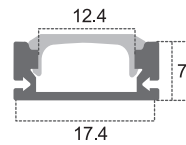

CL-Alu-508-SL
Available in 8ft and 10ft lengths



CL-Alu-508-BL (With Black and White PC Cover)
Available in 8ft and 10ft lengths

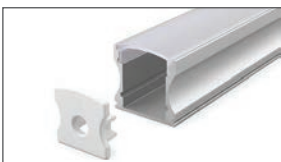
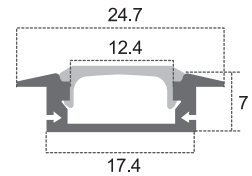

CL-Alu-613-SL

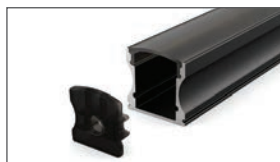

CL-Alu-613-BL (With Black and White PC Cover)

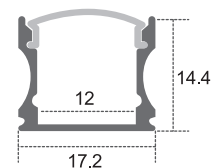

CL-Alu-613B-SL



CL-Alu-613B-BL (With Black and White PC Cover)

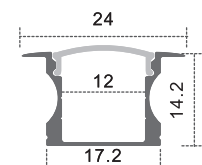

Dimensions are in millimeters

Aluminum Profiles

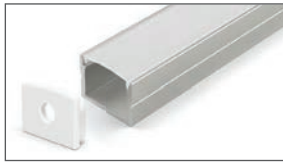

CL-Alu-1913S-SL

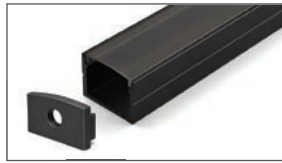

CL-Alu-1913S-BL (With Black and White PC Cover)

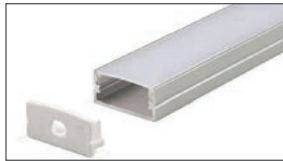
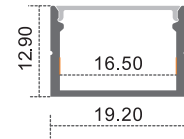
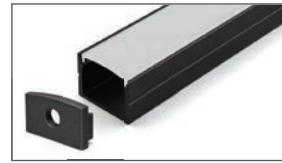

CL-Alu-617-SL



CL-Alu-617-BL (With Black and White PC Cover)

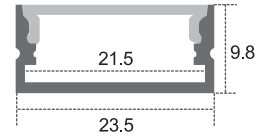

CL-Alu-619-SL



CL-Alu-619-BL (With Black and White PC Cover)

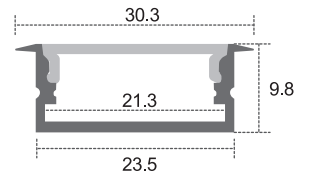

CL-Alu-5020-SL



CL-Alu-5020-BL (With Black and White PC Cover)

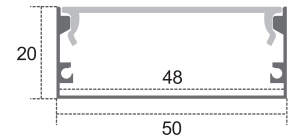

CL-Alu-632-SL

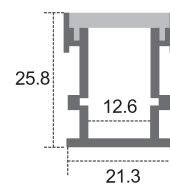

CL-Alu-712A-SL

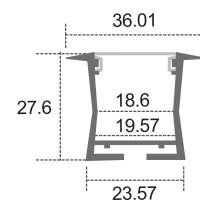

CL-Alu-601-SL
Available in 8ft and 10ft lengths

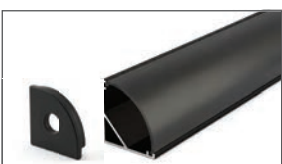

CL-Alu-601-BL (With Black and White PC Cover)
Available in 8ft and 10ft lengths

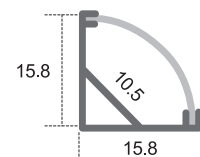

- Available in 8ft and 10ft length subject to model number
- High quality PC cover, No yellowish outlook
- Accessories are available

Dimensions are in millimeters

Aluminum Profiles

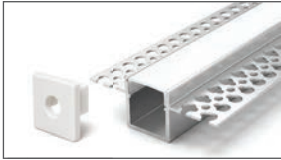

CL-Alu-5515-SL
Available in 8ft and 10ft lengths

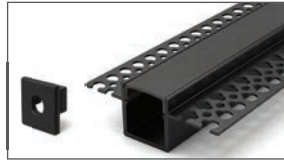

CL-Alu-5515-BL (With Black and White PC Cover)

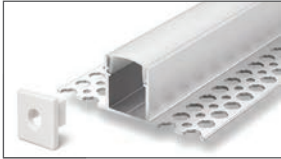
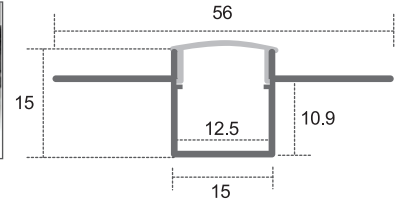
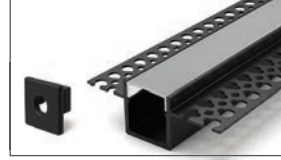

CL-Alu-5515A-SL

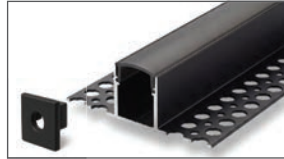

CL-Alu-5515A-BL (With Black and White PC Cover)

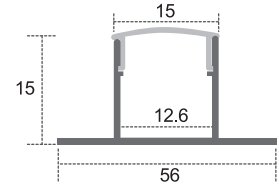
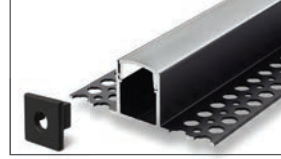

CL-Alu-6114-SL



CL-Alu-6114-BL (With Black and White PC Cover)

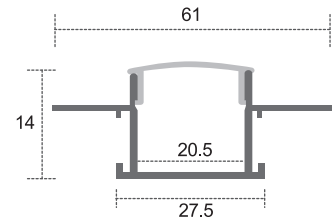

CL-Alu-6114A-SL

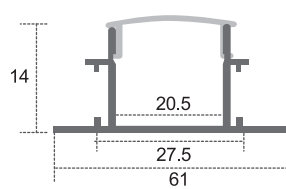

CL-Alu-4151-WH

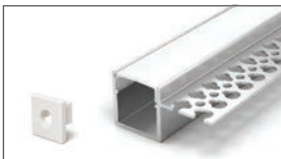
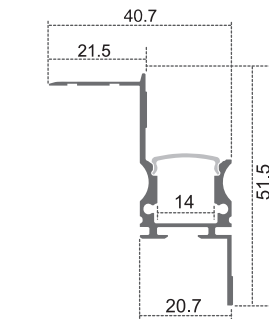

CL-Alu-3515-SL

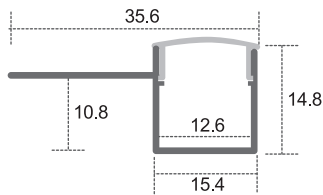

CL-Alu-3515A-SL

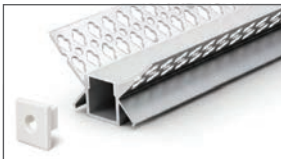
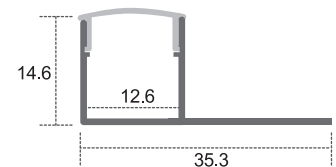

CL-Alu-4625-SL

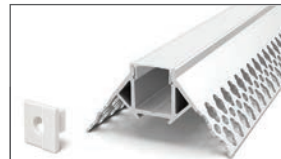
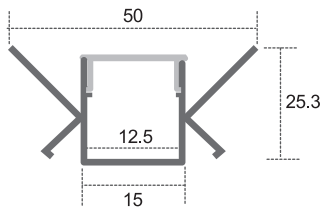

CL-Alu-5324-SL

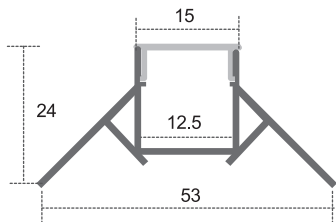

- Available in 8ft and 10ft length subject to model number
- High quality PC cover, No yellowish outlook
- Accessories are available

Dimensions are in millimeters

Aluminum Profiles



CL-Alu-9819-WH

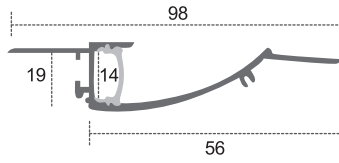

CL-Alu-7330-WH

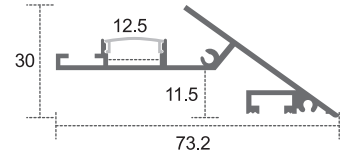

CL-Alu-5020PH-SL

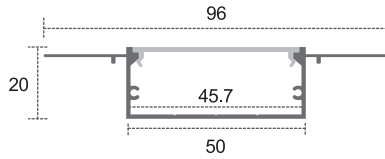

CL-Alu-9836M-WH

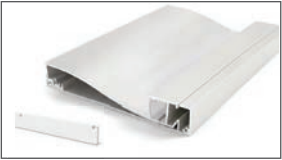
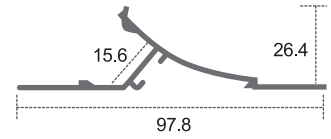

CL-Alu-10015-WH



CL-Alu-10015-BL

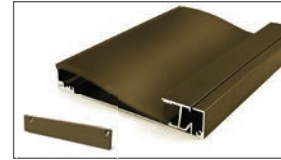

CL-Alu-10015-CH

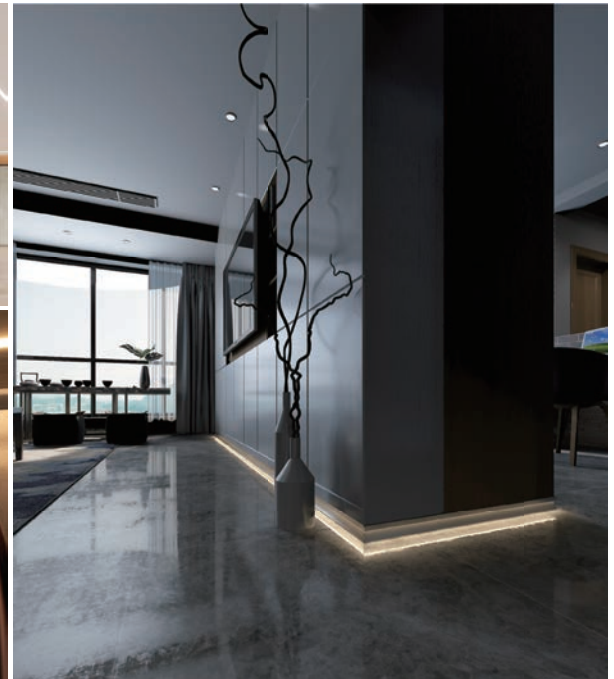
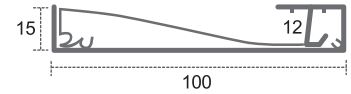

- Available in 8ft and 10ft length subject to model number
- High quality PC cover, No yellowish outlook
- Accessories are available

Dimensions are in millimeters

Bendable Aluminum Profiles



CL-Alu-7030-SL
Straight aluminum profile

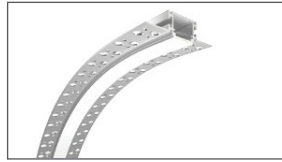

CL-Alu-7030UD-SL
Up & Down bendable aluminum profile

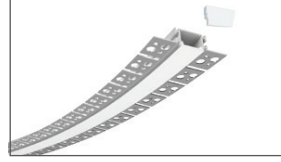

CL-Alu-7030LR-SL
Left & Right bendable aluminum profile

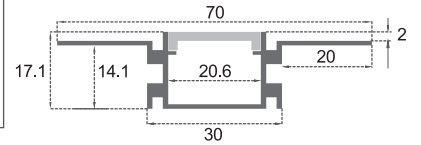

CL-Alu-1513-SL
Multi direction bendable aluminum profile

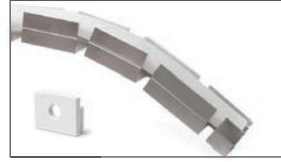
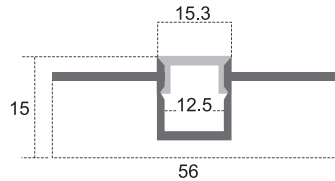

CL-Alu-1913-SL
Multi direction bendable aluminum profile

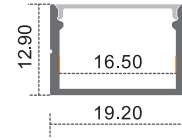

CL-Alu-640-SL
Up & Down bendable aluminum profile

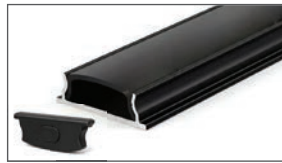

CL-Alu-640-BL (With Black and White PC Cover)
Up & Down bendable aluminum profile

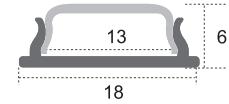

Bendable Aluminum profiles are 8ft length.

IP Rated Aluminum Profiles



CL-Alu-1217-8FT
Available in Black & Silver

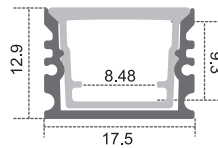

CL-Alu-1217A-8FT
Available in Black & Silver

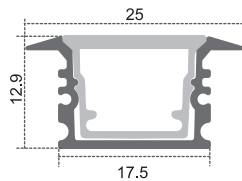

CL-Alu-2952 10ft length
Drive-over In-ground Aluminum Profile

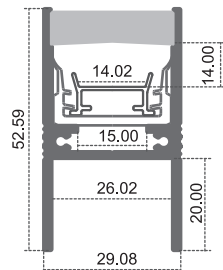

Dimensions are in millimeters





LED Sheets

cano light
Canadian Brightness

LED Sheets



Product Code	Input Voltage	Power	Lumen	Color Temp	LEDs/Sheet	Dimension
CL-LSH-392-4824-3K	24V DC	10W	800lm	3000K	392xSMD2835	(LxW) 480x240mm
CL-LSH-392-4824-4K				4000K		

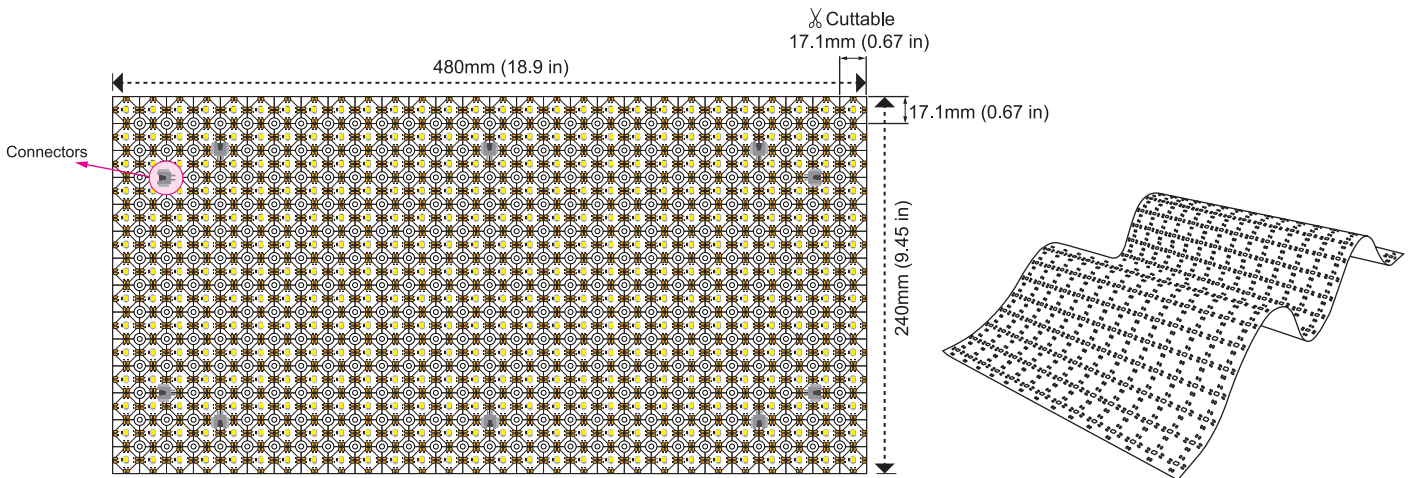

Accessories

CL-LSH-2P-BBW6	Double head connector with 6cm wire, 20Awg, 2pin
CL-LSH-2P-BBW30	Double head connector with 30cm wire, 20Awg, 2pin
CL-LSH-2P-XBW30	Single head connector with 30cm wire, 20Awg, 2pin



• cUL listed

Tunable LED Sheets

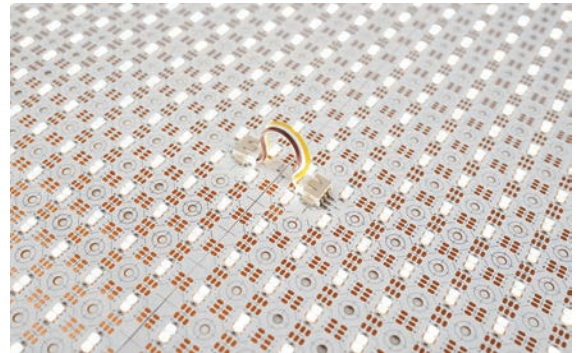

Product Code	Input Voltage	Power	Lumen	Color Temp	LEDs/Sheet	Dimension
CL-LSH-784-4824-TW	24V DC	20W	1600lm	Tunable 2700K~6000K	784xSMD2835	(LxW) 480x240mm

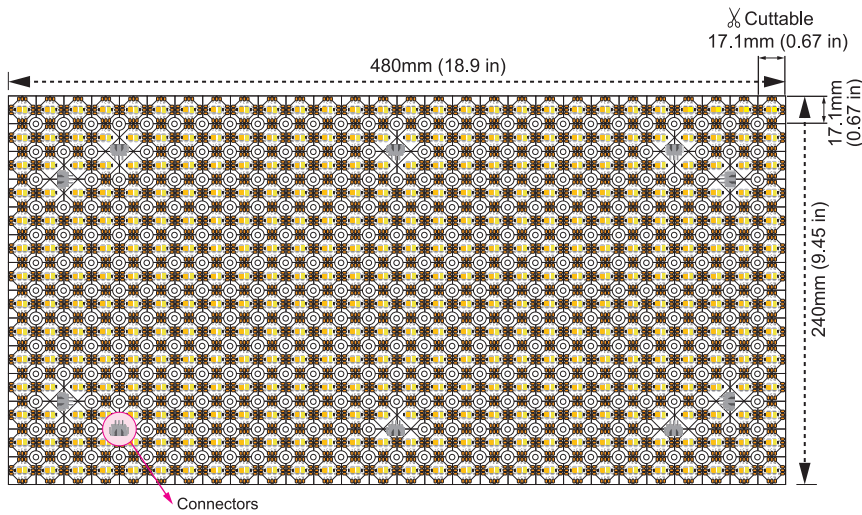

Accessories

- CL-LSH-3P-BBW6 Double head connector with 6cm wire, 20Awg, 3pin
- CL-LSH-3P-BBW30 Double head connector with 30cm wire, 20Awg, 3pin
- CL-LSH-3P-XBW30 Single head connector with 30cm wire, 20Awg, 3pin

• cUL listed

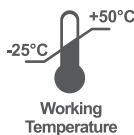

RGBW LED Sheets

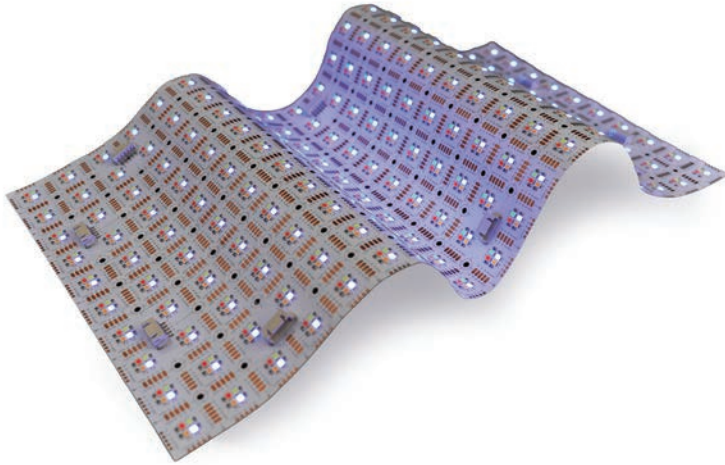

Product Code	Input Voltage	Power	Lumen	Color Temp	LEDs/Sheet	Dimension
CL-LSH-800-4824-RGBW	24V DC	24W	1176lm White	RGB+3000K	800xSMD2835	(LxW) 480x240mm

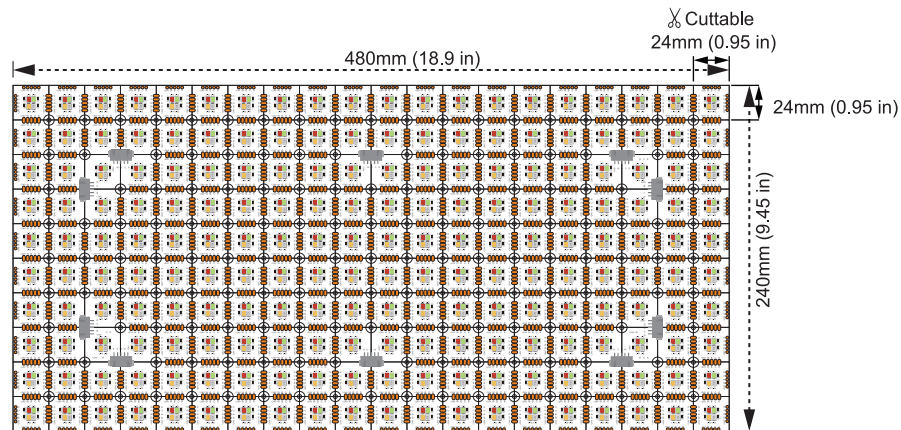

Accessories

CL-LSH-5P-BBW6

Double head connector with 6cm wire, 20Awg, 5pin

CL-LSH-5P-BBW30

Double head connector with 30cm wire, 20Awg, 5pin

CL-LSH-5P-XBW30

Single head connector with 30cm wire, 20Awg, 5pin

- cUL listed





LED Track Lights

cano light
Canadian Brightness

LED Track Lights

Professional series



Compatible with HALO 3-wire single circuit track system

Product Code	Input Voltage	Power	Lumen	Beam Angle	Color Temp	Body Color
CL-TRLH-10W-5CCT-30D-WH	120 VAC	10 W	1000lm	30°	5 CCT Adjustable	White
CL-TRLH-10W-5CCT-30D-BL	120 VAC	10 W	1000lm	30°	2700K 3000K	Black
CL-TRLH-20W-5CCT-36D-WH	120 VAC	20 W	2000lm	36°	3500K 4000K	White
CL-TRLH-20W-5CCT-36D-BL	120 VAC	20 W	2000lm	36°	5000K	Black

Installation accessories are available.

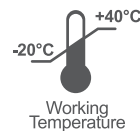
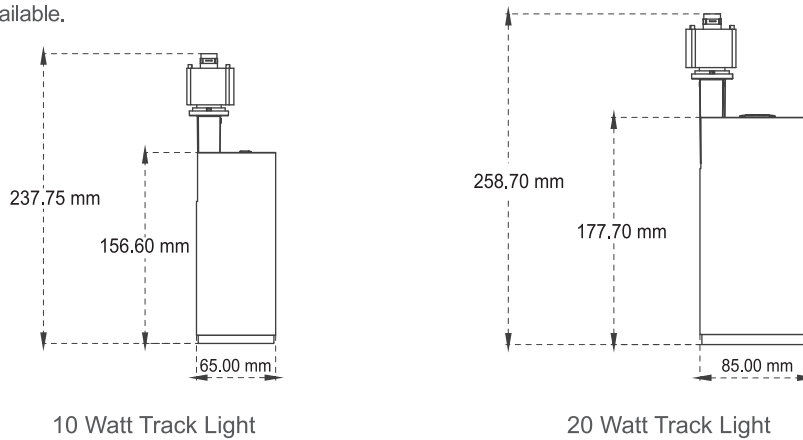

- PMMA lens
- Rotation 350° horizontal, 90° vertical
- cETL certificate

DOB LED Track Lights



Compatible with HALO 3-wire single circuit track system

Product Code	Input Voltage	Power	Lumen	Color Temp	Beam Angle	Body Color
CL-TRLH2-10W-5CCT-45D-WH	120 VAC	10 W	800lm	5 CCT Adjustable	45°	White
CL-TRLH2-10W-5CCT-45D-BL	120 VAC	10 W	800lm	2700K 3000K	45°	Black
CL-TRLH2-20W-5CCT-45D-WH	120 VAC	20 W	1600lm	3500K 4000K	45°	White
CL-TRLH2-20W-5CCT-45D-BL	120 VAC	20 W	1600lm	5000K	45°	Black

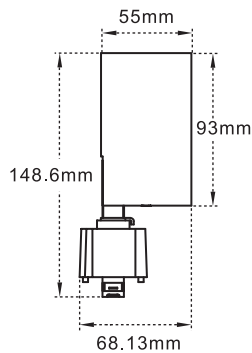

10 Watt Track Light

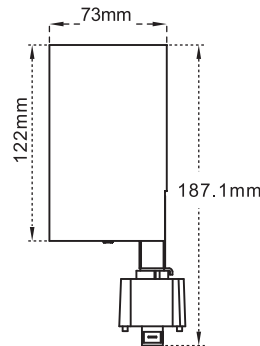
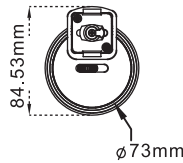

20 Watt Track Light

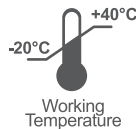

- PMMA lens
- Rotation 350° horizontal, 90° vertical
- cETL certificate

LED Pendant Track Lights



Compatible with HALO 3-wire single circuit track system

Product Code	Input Voltage	Power	Lumen	Color Temp	Beam Angle	Body Color
CL-TRLH-P74-10W-3CCT-WH	120VAC	10W	800lm	3CCT Adjustable 3000K-4000K-5000K	32°	White
CL-TRLH-P74-10W-3CCT-BL						Black

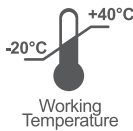
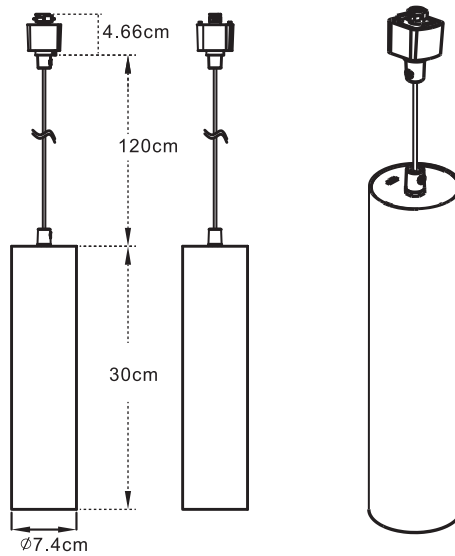

• cETL certificate

LED Track Lights | Zoomable Multi-mount

Default setup comes with a 3-wire (Halo) compatible track adapter with multiple mounting options available



Honeycomb included



CL-TRLH3-10W-5CCT-PDA



CL-TRLH3-20W-5CCT-PDA



CL-TRLH3-30W-5CCT-PDA

Product Code	IN Voltage	Power	Lumen	Color Temp	Beam Angle	Body Color
CL-TRLH3-10W-5CCT-PDA-WH	120 VAC	6W/8W/10W Adjustable	85lm/W	5 CCT Adjustable	24° - 60° Adjustable	White
CL-TRLH3-10W-5CCT-PDA-BL						Black
CL-TRLH3-20W-5CCT-PDA-WH	120 VAC	10W/15W/20W Adjustable	85lm/W	2700K 3000K 3500K 4000K 5000K	24° - 60° Adjustable	White
CL-TRLH3-20W-5CCT-PDA-BL						Black
CL-TRLH3-30W-5CCT-PDA-WH	120 VAC	20W/25W/30W Adjustable	85lm/W	5000K	24° - 60° Adjustable	White
CL-TRLH3-30W-5CCT-PDA-BL						Black

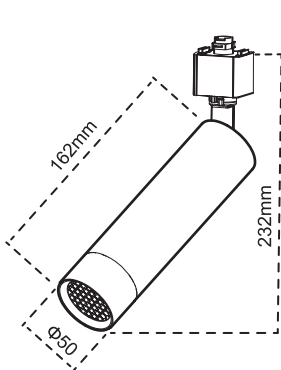

CL-TRLH3-10W-5CCT-PDA

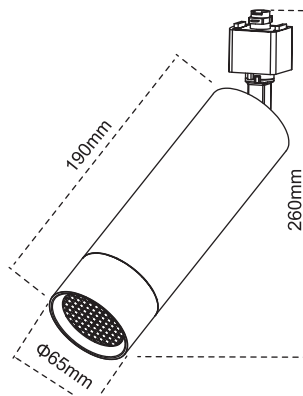

CL-TRLH3-20W-5CCT-PDA

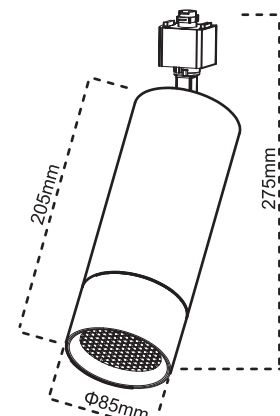

CL-TRLH3-30W-5CCT-PDA



- PMMA lens
- Rotation 350° horizontal, 90° vertical
- cETL certificate

LED Track Lights | Zoomable Multi-mount Accessories

Default setup comes with a 3-wire (Halo) compatible track adapter with multiple mounting options available.



PENDANT KIT

Body Color

CL-TRAH3-PENDANT-10-WH
 CL-TRAH3-PENDANT-10-BL
 Suitable for: CL-TRLH3-10W-5CCT-PDA

CL-TRAH3-PENDANT-20-WH
 CL-TRAH3-PENDANT-20-BL
 Suitable for: CL-TRLH3-20W-5CCT-PDA

CL-TRAH3-PENDANT-30-WH
 CL-TRAH3-PENDANT-30-BL
 Suitable for: CL-TRLH3-30W-5CCT-PDA

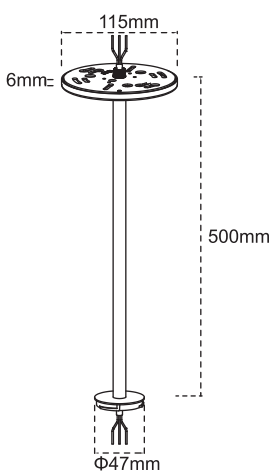

CL-TRAH3-PENDANT-10

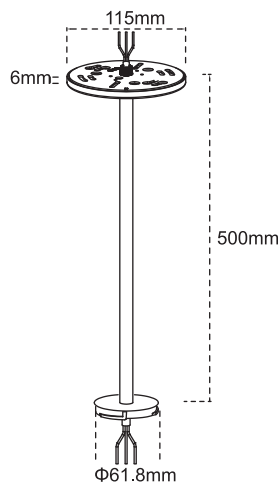

CL-TRAH3-PENDANT-20

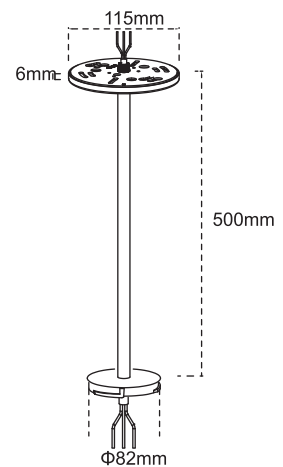

CL-TRAH3-PENDANT-30

LED Track Lights | Zoomable Multi-mount Accessories

Default setup comes with a 3-wire (Halo) compatible track adapter with multiple mounting options available.



SURFACE MOUNTED KIT Body Color

CL-TRAH3-SM-10-WH	White
CL-TRAH3-SM-10-BL	Black
Suitable for: CL-TRLH3-10W-5CCT-PDA	
CL-TRAH3-SM-20-WH	White
CL-TRAH3-SM-20-BL	Black
Suitable for: CL-TRLH3-20W-5CCT-PDA	
CL-TRAH3-SM-30-WH	White
CL-TRAH3-SM-30-BL	Black
Suitable for: CL-TRLH3-30W-5CCT-PDA	

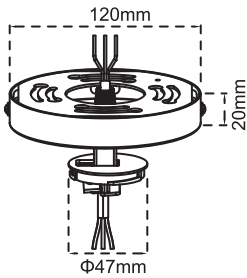

CL-TRAH3-SM-10

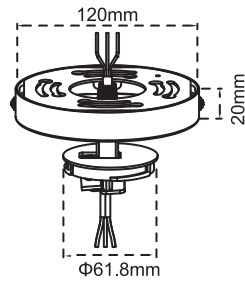

CL-TRAH3-SM-20

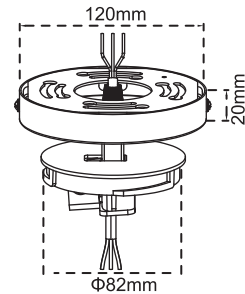

CL-TRAH3-SM-30

RECESSED MOUNTED KIT Body Color

CL-TRAH3-RM-10-WH	White
CL-TRAH3-RM-10-BL	Black
Suitable for: CL-TRLH3-10W-5CCT-PDA	
CL-TRAH3-RM-20-WH	White
CL-TRAH3-RM-20-BL	Black
Suitable for: CL-TRLH3-20W-5CCT-PDA	
CL-TRAH3-RM-30-WH	White
CL-TRAH3-RM-30-BL	Black
Suitable for: CL-TRLH3-30W-5CCT-PDA	

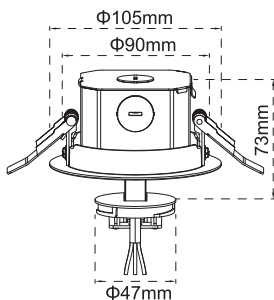

CL-TRAH3-RM-10

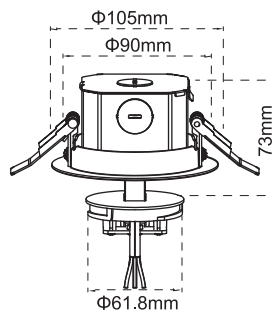

CL-TRAH3-RM-20

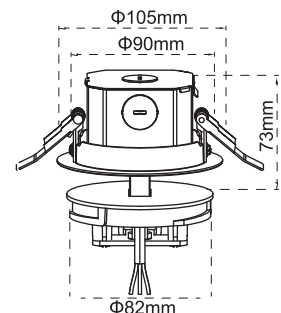

CL-TRAH3-RM-30

3-Wire Surface Mounted Tracks

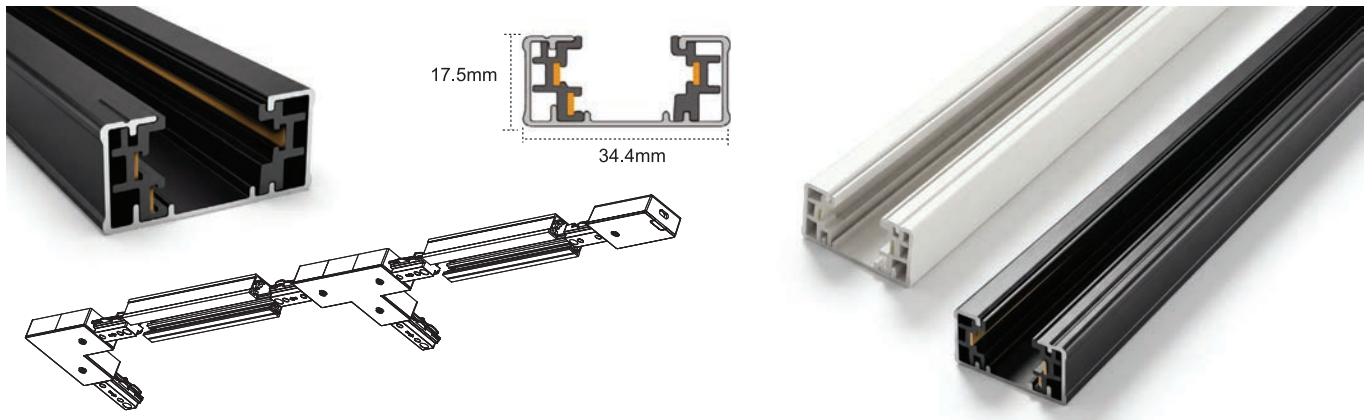

Product Code	Length	Color
CL-TR-4FT-WH	4 ft	White
CL-TR-4FT-BL		Black
CL-TR-6FT-WH	6 ft	White
CL-TR-6FT-BL		Black
CL-TR-8FT-WH	8 ft	White
CL-TR-8FT-BL		Black

Accessories

	CL-TRAH-INT-WH CL-TRAH-INT-BL			CL-TRAH-LCON-WH CL-TRAH-LCON-BL	
	CL-TRAH-SCON-A-WH CL-TRAH-SCON-A-BL			CL-TRAH-TCON-WH CL-TRAH-TCON-BL	
	CL-TRAH-SCON-B-WH CL-TRAH-SCON-B-BL			CL-TRAH-XCON-WH CL-TRAH-XCON-BL	
	CL-TRAH-BSCON-WH CL-TRAH-BSCON-BL			CL-TRAH-ENDCAP-WH CL-TRAH-ENDCAP-BL	
	CL-TRAH-CONDUIT-WH CL-TRAH-CONDUIT-BL			CL-TRAH-JBOX-WH CL-TRAH-JBOX-BL	

*To be used with CL-TRAH-INT.



LED Linear Lights

cano light
Canadian Brightness

Up & Down LED Linear Lights



Adjustable Proportion	
DOWN 100%	UP 0%
DOWN 90%	UP 10%
DOWN 70%	UP 30%

Product Code	Power	Lumen	CCT	Beam angle	Length
CL-LL1-225-3CCT	Adjustable 15/20/25W	130lm/W	3CCT	120° Diffused	2 ft
CL-LL1-450-3CCT	Adjustable 30/40/50W	130lm/W	Adjustable 3000K 3500K 4000K	120° Diffused	4 ft
CL-LL1-8100-3CCT	Adjustable 60/80/100W	130lm/W	4000K	120° Diffused	8 ft

- Body Color available in Black and White
- Seamless connection
- Input Voltage: 120-347VAC 50/60Hz
- Bridgelux LED chip
- Flicker free isolated driver
- Pendant/Surface/Recessed/Wall-mount/T-bar installation kits are available
- cUL Certificate

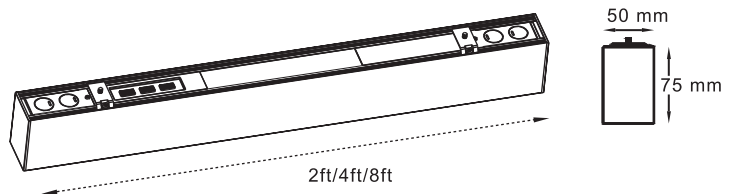

AC
120-347V
50/60Hz

0-10V
DIMMABLE

CRI
> 90

5
YEARS
WARRANTY

Lifetime
>50,000 hrs

-20°C +40°C

Working Temperature

Up & Down LED Linear Light Accessories

Body Color available in Black and White



CL-LL1A-CROSS
Cross corner

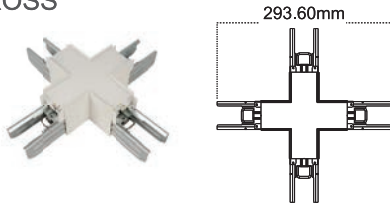

CL-LL1A-T corner
T corner

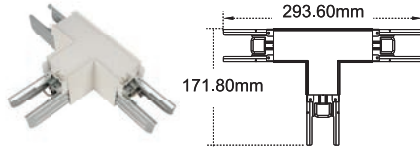

CL-LL1A-V120 corner
120 degree connector

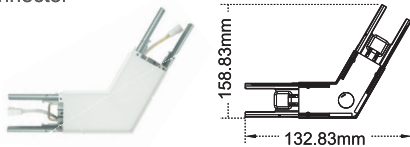

CL-LL1A-L corner
L corner

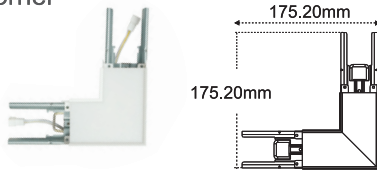

CL-LL1A-Y corner
Y connector

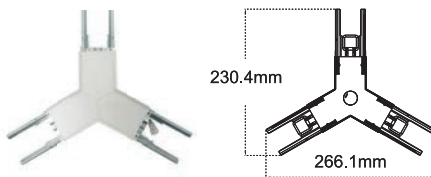

CL-LL1A-SCON
Straight connector

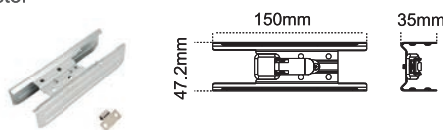

CL-LL1A-WMA
Wall mount



CL-LL1A-PC cover
Diffuser



CL-LL1A-surface mount kit
Surface mount kit

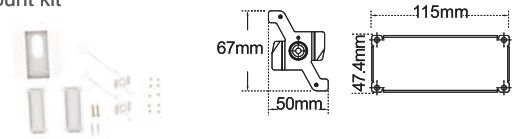

CL-LL1A-PKC
Canopy pendant kit



CL-LL1A-AC wire
AC Wire with connector

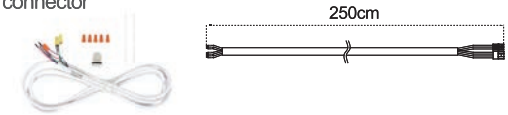

CL-LL1A-Safety wire
Safety wire

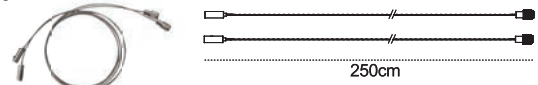

CL-LL1A-PSMC
Plug in sensor



CL-LL1A-PSMI
Plug in sensor

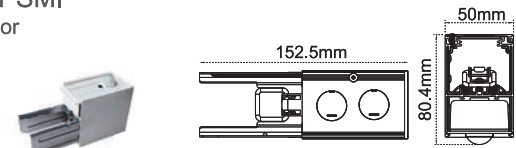

CL-LL1A-PSMI-PRO
Plug in sensor

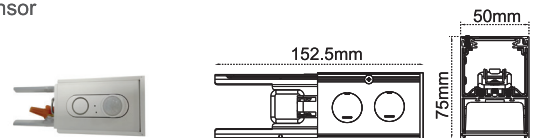

CL-LL1A-PSMI-PRO-REMOTE
Remote controller for CL-LL1A-PSMI-PRO



CL-LL1A-RK2 Recessed Kit 2ft

CL-LL1A-RK4 Recessed Kit 4ft

CL-LL1A-RK8 Recessed Kit 8ft



Step & Handrail Controllers

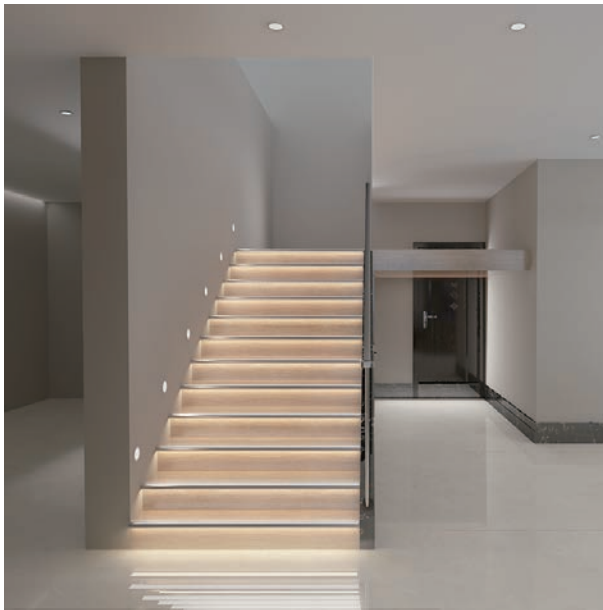

Model Number	CL-CONT-STEP-28
Input Voltage	12-24VDC
Power	Each Step <15W Total <420W
Output Channel	28 Channels
Main Application	Step Controller

Model Number	CL-CONT-PIXEL-512
Input Voltage	12-24VDC
Max Pixel QTY	512
Support IC	WS2811, WS2818, SM16703, TM1903
Main Application	Handrail Controller

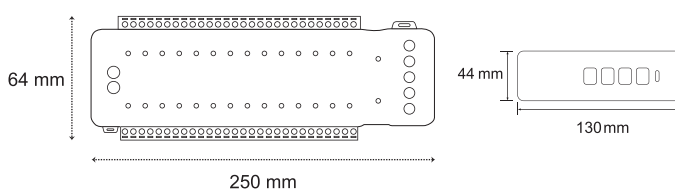

CL-CONT-STEP-28

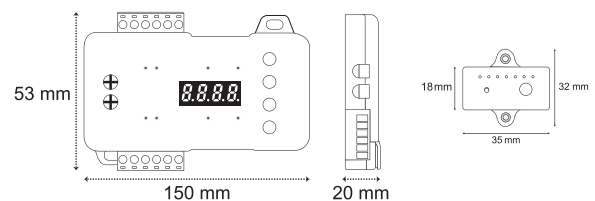

CL-CONT-PIXEL-512

- 2 Motion sensors are included
- Visit Canolight website to download user manual
- 3-Year Warranty

Chaseable Strip Light Controller



Model Number	CL-AST-RFCSPI01-LV
Input Voltage	12-24VDC
Output	Max 2048 Pixels
Communication	RF2.4GHz
Supported Strip Types	Chaseable strip light controller



Model Number	CL-AST-RFRRFBK-LV
2.4GHz Remote Controller compatible with CL-AST-RFCSPI01-LV 4zones	

Single color|3CCT|RGB|RGBW|RGBCW Strip light controller

5 in 1 Controller



Model Number	CL-AST-SWCWL5-LV
Input Voltage	12-48VDC
Total Output	6A/channel, Max 15A
Communication	Wifi RF2.4GHz Tuya app(Mobile)
Supported Strip Types	Single color, 3CCT, RGB RGBW RGBCW and tunable White strip lights



cUL certified

Model Number	CX-W01-P5-12A-RGBCW controller
Input Voltage	12-48VDC 144W @ 12V, 288W @ 24V
Total Output	5 channels, Max 4A per channel, Max output 12A
Communication	Wifi RF2.4GHz Tuya app(Mobile)
Supported Strip Types	Single color, 3CCT, RGB RGBW RGBCW and tunable White strip lights



Model Number	CL-AST-RFCLS2-LV
Input Voltage	12-48VDC
Total Output	6A/channel, Max 15A
Communication	RF2.4GHz
Supported Strip Types	Single color, 3CCT, RGB RGBW RGBCW and tunable White strip lights



Model Number	CL-AST-RFRFUT092-LV
Communication	2.4 GHz RF Remote Controller ,4 Zones

Compatible with CL-AST-RFCLS2-LV | CL-AST-SWCWL5-LV | CX-W01-P5-12A-RGBCW controllers

Visit Canolight website to download user manual.

Door & Hand Sweep Sensor

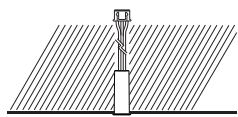
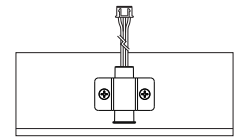

Product Code	CL-AST-SENS-HS
Sensor Type	Hand Sweep Sensor
Detection Range	Up to 10 cm
Detection Angle	15°-30°

Product Code	CL-AST-SENS-DS
Sensor Type	Door Sensor
Detection Range	Up to 10 cm
Detection Angle	15°-30°

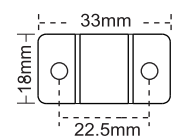
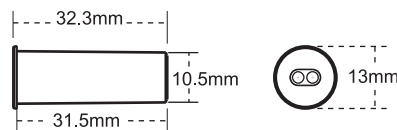
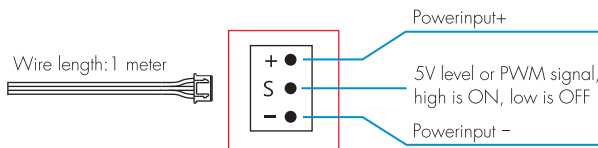

Hand Sweep / Door Control Infrared wireless Sensing Head

Sensor controller

Product Code	CL-AST-E1-L
Input Voltage	12-48V DC 8A Max 96-384W

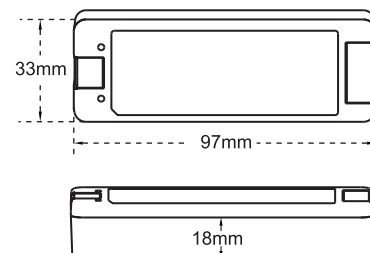

Combined Constant Voltage LED Driver + Dimmer

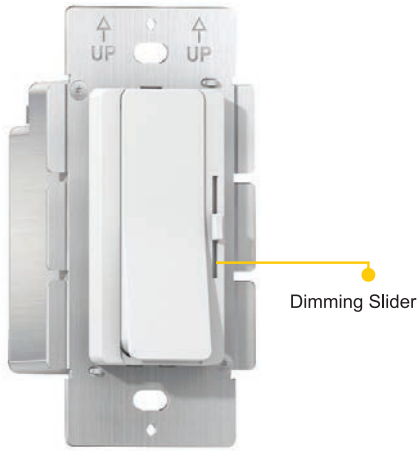

CDR1 Series, 2 in 1 LED Driver + Dimmer

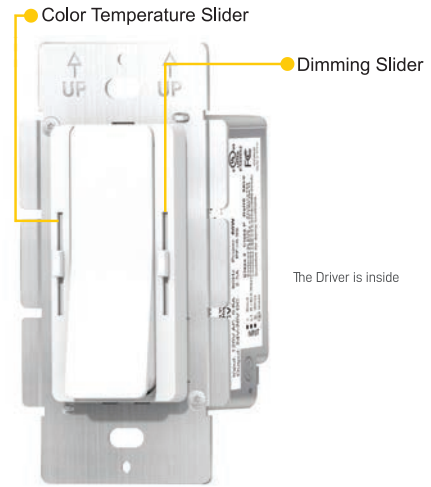

CDR2 Series, All in 1 LED Driver + Dimmer + CCT Slider
Compatible with **tuya** app by **WiFi** and **Bluetooth**

Product Code	Input Voltage	Output	Power	Power Factor
CL-CDR1-CV-60W-24V-DIM	120V AC	24V-26V DC	60W	≥0.99
CL-CDR1-CV-96W-24V-DIM			96W	
CL-CDR2-CV-60W-24V-DIM	120V AC	24V-26V DC	60W	≥0.99
CL-CDR2-CV-96W-24V-DIM			96W	

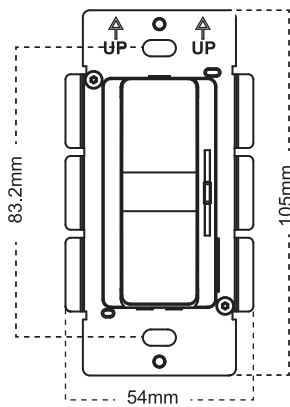

CL-CDR1-CV-60W-24V-DIM
CL-CDR1-CV-96W-24V-DIM

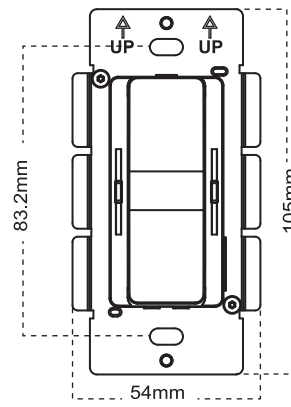

CL-CDR2-CV-60W-24V-DIM
CL-CDR2-CV-96W-24V-DIM



• cUL listed

Class 2 Constant Voltage LED Drivers



Product Code	IN Voltage	Power	OUT Voltage	OUT Current	PF	DIM
CL-DR-CV-60W-24V-DIM	120-277 VAC 50/60Hz	60 W	24 VDC	2.5 A	0.95	Triac Dimmable
CL-DR-CV-96W-24V-DIM	120-277 VAC 50/60Hz	96 W	24 VDC	4 A	0.95	Triac Dimmable
CL-DR-CV-150W-24V-DIM	120-277 VAC 50/60Hz	150W 75W x 2 channels	24 VDC	3.125A per channel	0.9	5 in 1 Dimmable
CL-DR-CV-200W-24V-DIM	120-277 VAC 50/60Hz	198.24W 99.12W x 2 channels	24 VDC	8.25A per channel	0.9	5 in 1 Dimmable
CL-DR-CV-300W-24V-DIM	120-277 VAC 50/60Hz	297.36W 99.12W x 3 channels	24 VDC	12.39A per channel	0.9	5 in 1 Dimmable

Compatible Triac Dimmers	Brand	Model
	Lutron	AYCL-153P, DV-600PR, DVCL-153P, MACL-153MH, MRF2-6CL, D-600P, NTELV-300P, S-600P, CT-600P, CTCL-153P, TG-600P, TCCL-153P, SFTU-5A3P, PD-6WCL, 6681, 6672
	Leviton	6633, 6674, 6602, IPL06, 6621, 6672, DSL06, DVCL-153P, CTCL-153P, TGCL-153P
	Legrand	ADTP703TU, H703PTW
	Cooper	9540, DAL06P

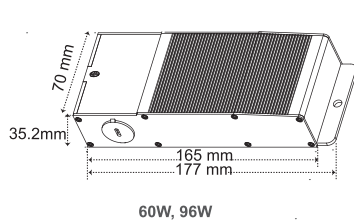

60W, 96W

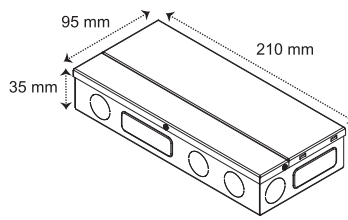

150W, 200W

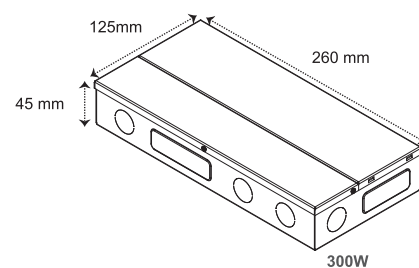

300W



- o Do not load more than 80% of driver capacity
- Flicker-free dimming
- Overload, thermal and short circuit protection
- cETL certified, comply with UL8750

Constant Voltage Economy LED Drivers



Product Code	IN Voltage	Power	OUT Voltage
CL-EDR-CV-24W-24V-DIM	120VAC 60Hz	24W	24VDC
CL-EDR-CV-60W-24V-DIM	120VAC 60Hz	60W	24VDC
CL-EDR-CV-96W-24V-DIM	120VAC 60Hz	96W	24VDC
CL-EDR-CV-60W-12V-DIM	120VAC 60Hz	60W	12VDC
CL-EDR-CV-96W-12V-DIM	120VAC 60Hz	96W	12VDC

*CL-EDR-CV-96W-12V-DIM is not Class 2

Compatible Triac Dimmers				
Brand	Series	Model	Wattage Range	Dimming Range
LUTRON	Diva	DVCL-153P	24W-150W	0%-100%
	Skylark	SCL-153P	24W-150W	0%-100%
	Maestro	MACL-153M	24W-150W	0%-100%
	Ariadni	AYCL-153P	24W-150W	0%-100%
	Caseta	PD-6WCL	24W-150W	0%-100%
LEVITON	Decora	6674-P	24W-150W	0%-100%
	SureSlide	6672	24W-150W	0%-100%
	IllumaTech	IPL06	24W-150W	0%-100%
	Decora Smart	DW6HD-1BZ	24W-150W	0%-100%
	Trimatron	6683-I	24W-150W	0%-100%
LEGRAND	Radiant	RHCL453PTCCCV6	24W-150W	0%-100%
	Adorne	ADTP703TU	24W-150W	0%-100%
	Pass & Seymour	LSCL453PTC	24W-150W	0%-100%
	Harmony	H703PTUTC	24W-150W	0%-100%
	Pass & Seymour	HCL453PTCCCV6	24W-150W	0%-100%
COOPER	AL Series	AL dimmer	24W-150W	0%-100%
	Devine	DAL06P-C1	24W-150W	0%-100%
	Aspire	9540-N	24W-150W	0%-100%
	Decorator	DAL06P-C2-K	24W-150W	0%-100%
	Halo	RL06P-C1-K	24W-150W	0%-100%

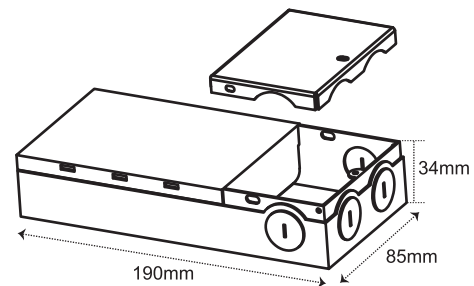
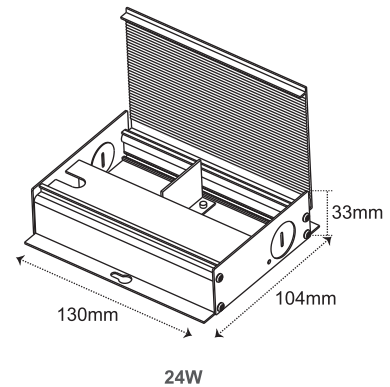

- o Do not load more than 80% of driver capacity
- 24W and 60W drivers are suitable for dry locations
- 96W drivers are suitable for damp locations
- cETL approved

Ultra Slim Constant Voltage LED Driver



Product Code	Input Voltage	Power	OUT Voltage	DIM
CL-UDR-CV-60W-24V-DIM	120VAC 60Hz	60W	24 VDC 2.5A	ELV/MLV/TRIAC ELECTRONIC DIM
CL-UDR-CV-96W-24V-DIM		96W	24 VDC 4A	

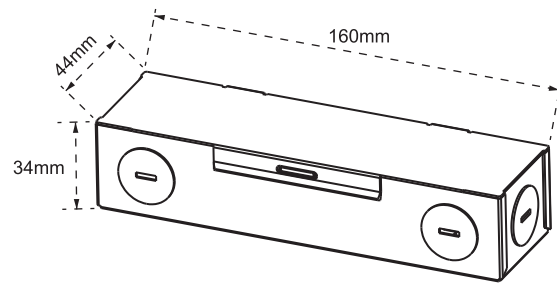

Constant Voltage LED Disk Driver

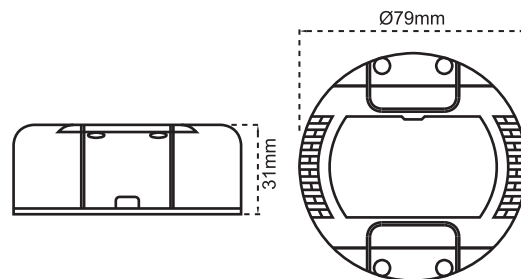

Product Code	Input Voltage	Power	OUT Voltage	IP	DIM
CL-DDR-CV-60W-24V-DIM	90-130VAC 50/60Hz	60W	24 VDC	20	Triac Dimmable



- Flicker-free dimming
- Overload, thermal and short circuit protection
- cETL approved

Constant Voltage Commercial LED Drivers



OTM-PDJ96-J24
96W



OTM-PDJ200-J24
200W

Product Code	Input Voltage	Power	OUT Voltage	DIM
OTM-PDJ96-J24	200-347VAC	96W	24 VDC	0-10V Dim
OTM-PDJ200-J24	200-347VAC	200W	24 VDC	0-10V Dim

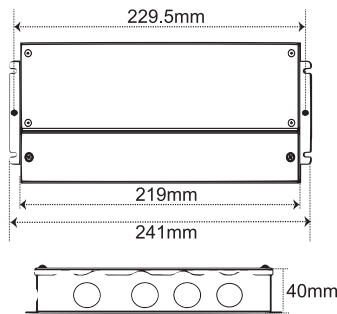
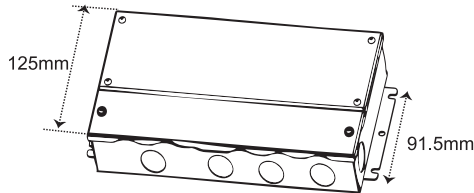

96W

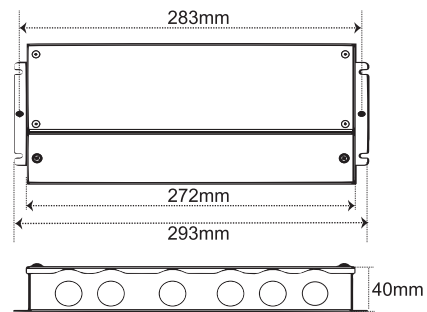
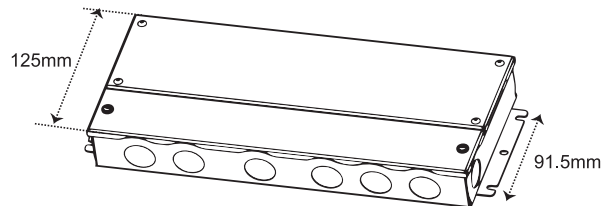

200W



- cUL approved
- Do not load more than 80% of driver capacity

Class 2 Constant Voltage Plugin LED Driver



Product Code	Input Voltage	Power	OUT Voltage	IP
CL-PDR-CV-60W-24V	100-240VAC	60W	24 VDC 2.5A	20
CL-PDR-CV-96W-24V	50/60Hz	96W	24 VDC 4A	

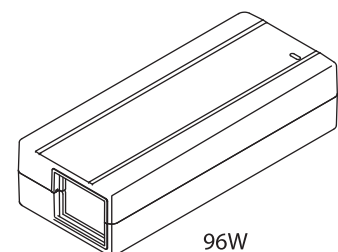
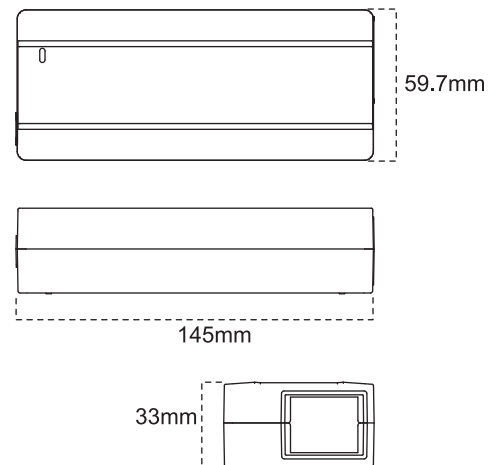
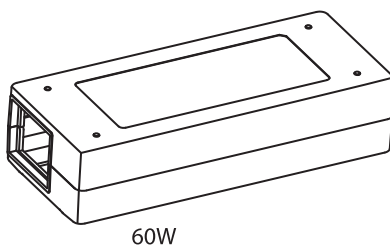
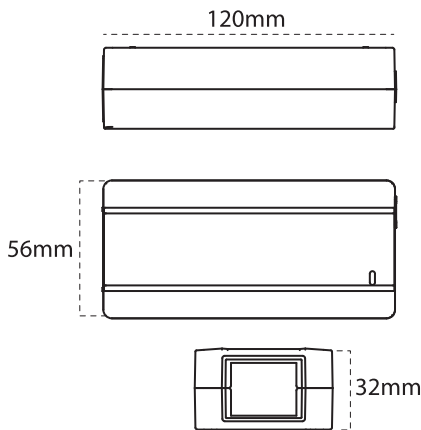

For Indoor use only

Outdoor Constant Voltage LED Drivers



96W



192W

Product Code	Input Voltage	Power	OUT Voltage	OUT Current	IP
CL-ODR2-CV-96W-24V-DIM	110-277VAC	96W	24 VDC	4A Max	68
CL-ODR2-CV-192W-24V-DIM	110-277VAC	96W x 2 channels	24 VDC	2x4A Max	68

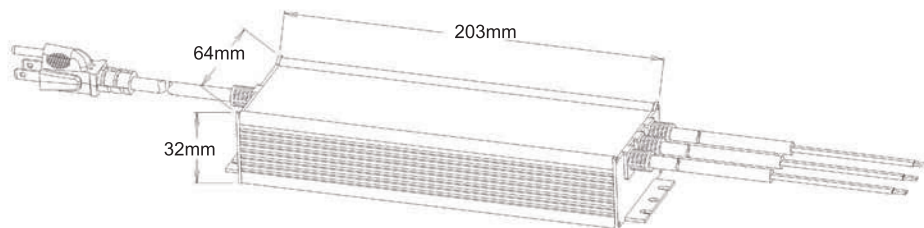

96W
Dimensions: 224x64x32 mm(LxWxH)
The overall length including the end caps

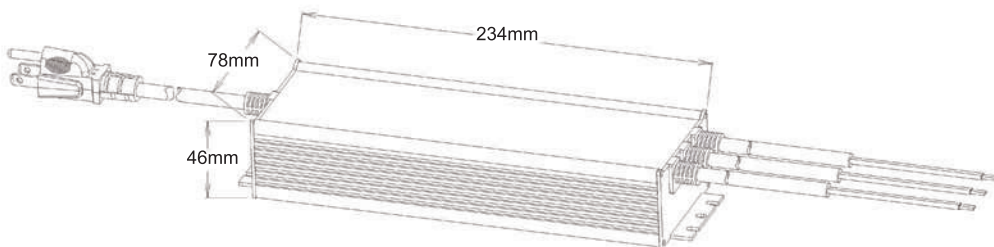

192W
Dimensions: 258x78x46 mm(LxWxH)
The overall length including the end caps

- Do not load more than 80% of driver capacity
- Triac/Phase, 0-10V, 1-10V, Potentiometer, 10V PWM Dimming (5 in 1)
- Over current, short circuit and over voltage protection
- Suitable for outdoor use
- cUL approved



Outdoor Transformers



100W



200W



300W

Product Code	IN Voltage	Power	OUT Voltage	Housing	Core
CL-ODR-CV-100W	120VAC 60Hz	100W	12VAC	PC+UV	Brass
CL-ODR-CV-200W	120VAC 60Hz	200W	12V&15V AC Double Channel	PC	Brass
CL-ODR-CV-300W-PRO	120VAC 60Hz	300W	12V/13V/14V/15V AC Single Channel	304 Stainless Steel	Brass

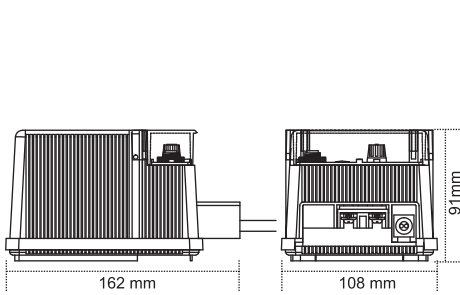

100W

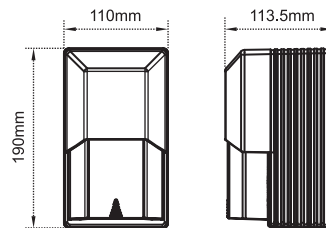

200W

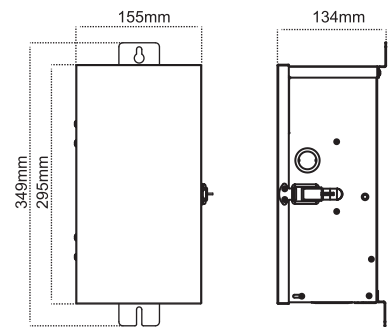

300W

300W Accessories

CL-ODRA-PhotoCell-JL104A



CL-ODRA-Timer-HU21M



CL-ODRA-WIFI socket-LSPA6



- 100W and 200W transformers come with integrated timer and photocell
- Accessories are available for 300W transformer including timer, photocell and WIFI socket
- Suitable for outdoor use
- cUL approved (100W Transformer)
- cETL approved (200W and 300W Transformers)
- Do not load more than 80% of transformer capacity



INDUSTRIAL LIGHTS

cano  light
Canadian Brightness

Industrial UFO High Bay Lights



DLC Premium Listed



Product Code	Input Voltage	Power	Lumen	Color Temp
CL-IND-UFO1-150W-3CCT-BL	120-347VAC 50/60Hz	Adjustable 100W/120W/150W	138lm/W (3500K) 158lm/W (4000K) 151lm/W (5000K)	3CCT Adjustable 3500K 4000K 5000K
CL-IND-UFO1-240W-3CCT-BL	120-347VAC 50/60Hz	Adjustable 160W/200W/240W	140lm/W (3500K) 160lm/W (4000K) 146lm/W (5000K)	

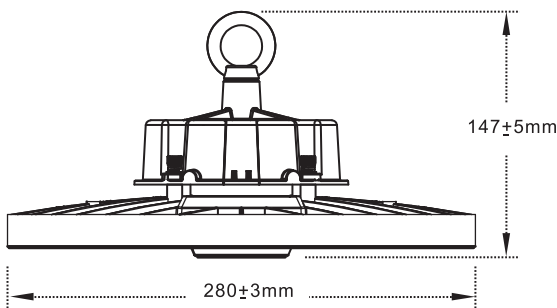

CL-IND-UFO1-150W-3CCT-BL

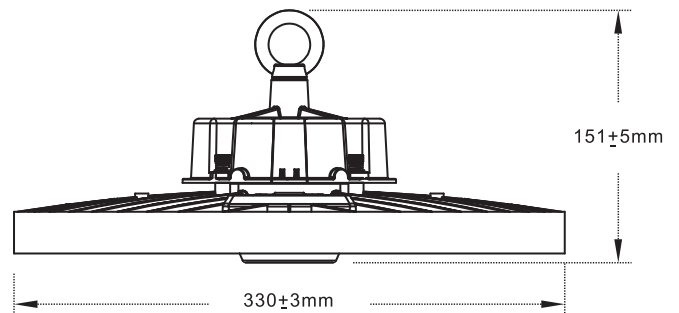

CL-IND-UFO1-240W-3CCT-BL



- 6ft power and dimming cords included.
- Hook and sensor base included.
- Aluminum die-cast body with PC lens
- cUL certificate

Industrial UFO Accessories



CL-ACC-UFO1-EMERGENCY DRIVER-30W
Emergency driver for CL-IND-UFO1-150W-3CCT-BL

CL-ACC-UFO1-EMERGENCY DRIVER-40W
Emergency driver for CL-IND-UFO1-240W-3CCT-BL



CL-ACC-UFO1-SM KIT 150/240
Surface mount kit



CL-ACC-UFO1-PC COVER150
PC cover for CL-IND-UFO1-150W-3CCT-BL

CL-ACC-UFO1-PC COVER240
PC cover for CL-IND-UFO1-240W-3CCT-BL



CL-ACC-UFO1-ALU COVER150
Aluminum cover for CL-IND-UFO1-150W-3CCT-BL

CL-ACC-UFO1-ALU COVER240
Aluminum cover for CL-IND-UFO1-240W-3CCT-BL



CL-ACC-UFO1-PC LID 150/240
PC Lid



CL-ACC-UFO1-WG150
Web guard for CL-IND-UFO1-150W-3CCT-BL

CL-ACC-UFO1-WG240
Web guard for CL-IND-UFO1-240W-3CCT-BL



CL-ACC-IND-MOTION SENSOR
Motion sensor, detection distance 15 meters



CL-ACC-IND-PIR SENSOR
PIR sensor, detection distance 12 meters



CL-ACC-IND-REMOTE CONTROLLER
Remote controller for motion and PIR sensors



CL-ACC-UFO1-Safety Hanger

LED Linear High Bay Lights



DLC Premium Listed



Product Code	Input Voltage	Power	Lumen	Color Temp
CL-IND-LHB1-2FT-165W-3CCT-WH	120-347ACV 50/60Hz	Adjustable 130W/150W/165W	138lm/W (3500K)	3CCT Adjustable 3500K 4000K 5000K
			151lm/W (4000K)	
			140lm/W (5000K)	
CL-IND-LHB1-4FT-220W-3CCT-WH	120-347ACV 50/60Hz	Adjustable 180W/200W/220W	138lm/W (3500K)	3CCT Adjustable 3500K 4000K 5000K
			153lm/W (4000K)	
			142lm/W (5000K)	

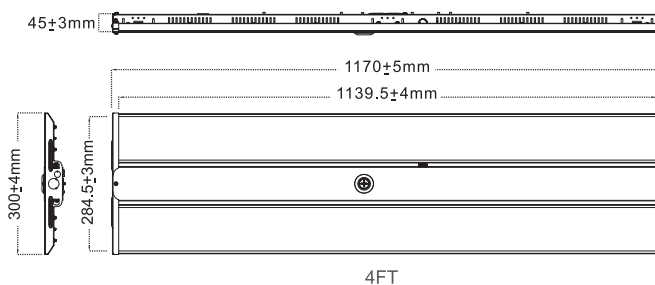
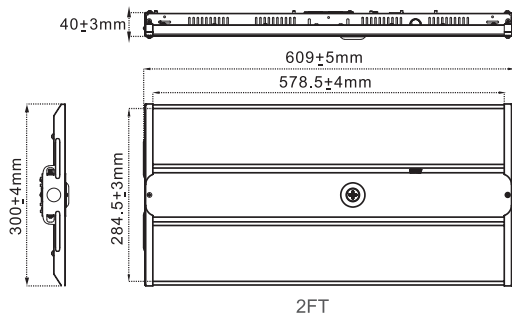

- 6ft power and dimming cords included.
- Chain and sensor base included.
- cUL certificate

LED Linear High Bay Accessories

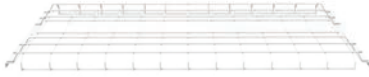

CL-ACC-LHB1-WG165

Wire guard for 2ft (CL-IND-LHB1-2FT-165W-3CCT-WH)

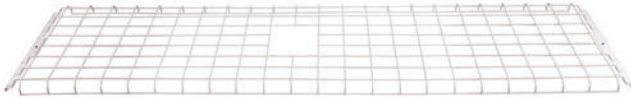

CL-ACC-LHB1-WG220

Wire guard for 4ft (CL-IND-LHB1-4FT-220W-3CCT-WH)



CL-ACC-LHB1-EMERGENCY DRIVER-16W

Emergency Driver



CL-ACC-LHB1-PENDANT KIT

Pendant kit



CL-ACC-LHB1-SM KIT

Surface mount kit



CL-ACC-IND-MOTION SENSOR

Motion sensor, detection distance 15 meters



CL-ACC-IND-PIR SENSOR

PIR sensor, detection distance 12 meters



CL-ACC-IND-REMOTE CONTROLLER

Remote controller for motion and PIR sensors

Industrial LED Strip Lights



Product Code	Input Voltage	Power	Lumen	Color Temp
CL-IND-ST1-4FT-40W-5CCT-WH	120-347VAC 50/60Hz	Adjustable 20W/30W/40W	120-140lm/W	5CCT Adjustable 3000K 4000K 5000K 5700K 6500K
CL-IND-ST1-8FT-80W-5CCT-WH	120-347VAC 50/60Hz	Adjustable 60W/70W/80W	120-140lm/W	

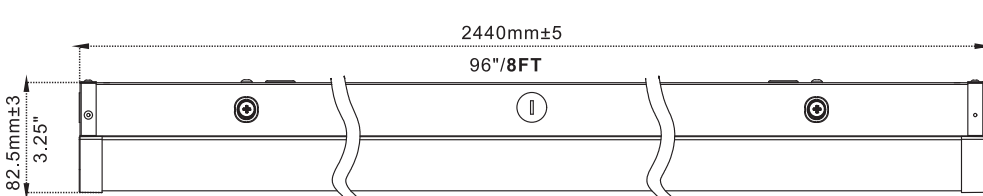
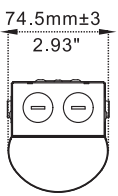
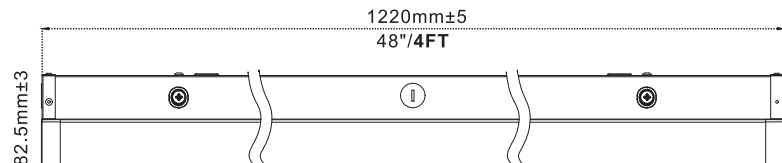
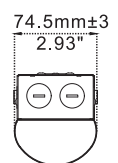

DIMMABLE
0-10V

DAMP
LOCATION

PF
≥ 0.9

CRI
> 80

90°
Beam Angle

Flicker Free

5
YEARS
WARRANTY

- Surface mount kit included
- cUL certificate

Industrial LED Strip Light Accessories



CL-ACC-ST1-PENDANT KIT
Pendant kit



CL-ACC-ST1-MBS
Middle bracket to join industrial strip light in surface mount installation



CL-ACC-ST1-MBP
Middle bracket to join industrial strip light in pendant installation



CL-ACC-ST1-MOTION SENSOR
Motion sensor



CL-ACC-ST1-EMERGENCY DRIVER-8W
8W Emergency driver

Constant power	Battery	Emergency time	Output current
25-48VDC 8W	Li-ion battery 7 4V2500mA	1.5 Hours	160-320mA



LED Linear High Bay Lights

cano light
Canadian Brightness