

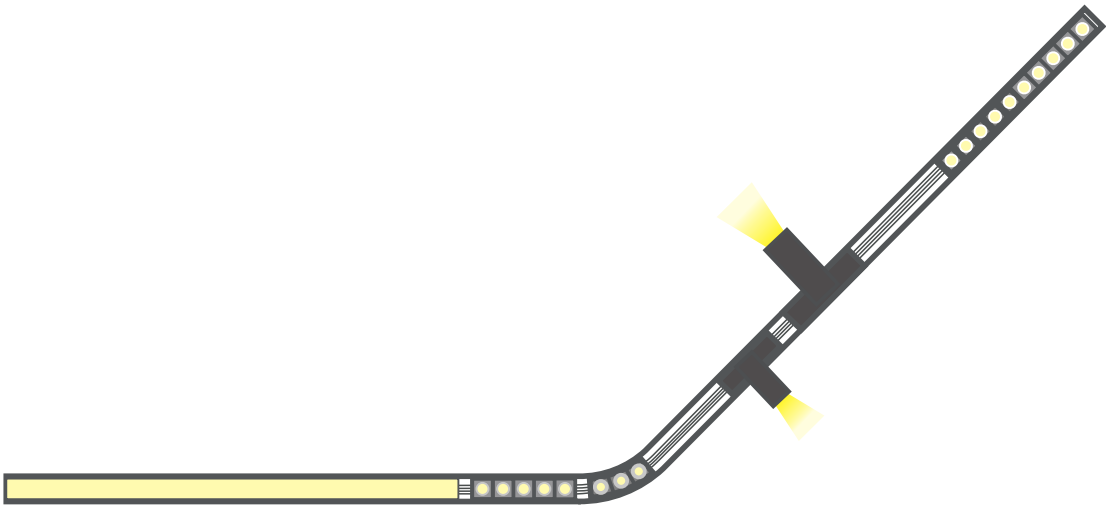

Magnetic track light system

Installation Manual



Standard Version

www.canolight.ca

SURFACE/PENDANT/RECESSED

1M PROFILE 997mm (39.3")

2M PROFILE 1992mm (78.43")

3M PROFILE 2997mm (118")

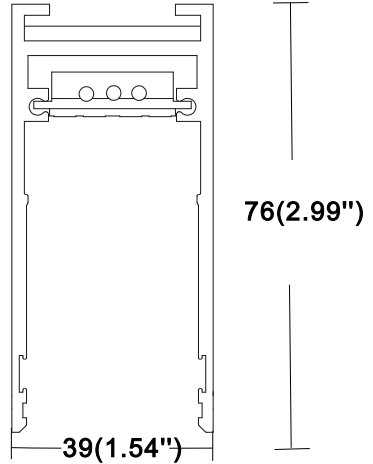
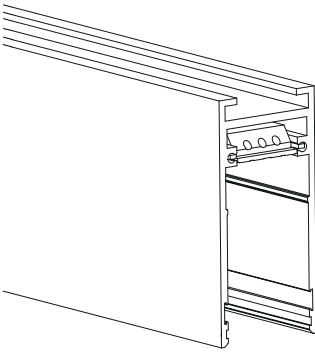

TRIMLESS RECESSED WITH FLANGE

1M PROFILE-R 997mm (39.3")

2M PROFILE-R 1992mm (78.43")

3M PROFILE-R 2997mm (118")

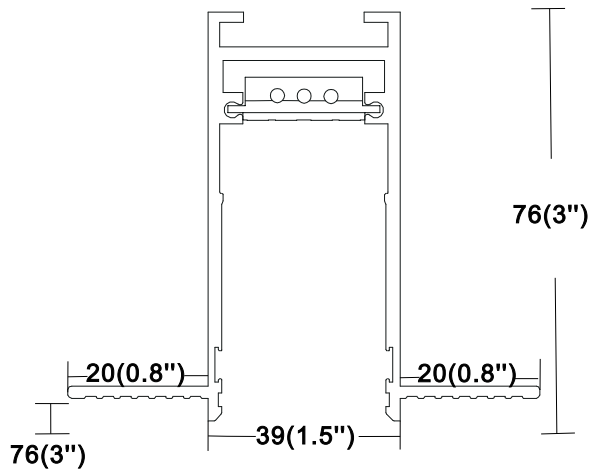
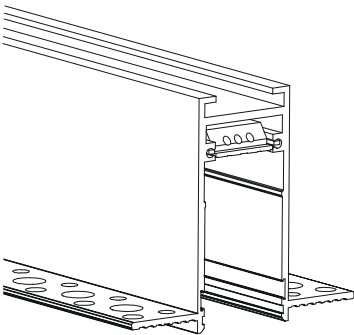

CAUTION:

1. BEFORE INSTALLING THE LIGHT FIXTURES, PLEASE READ THE INSTALLATION INSTRUCTIONS CAREFULLY.
2. DISCONNECT POWER AT CIRCUIT BREAKER BEFORE INSTALLATION OR SERVICING.
3. DO NOT INSTALL THE TRACK IN DAMP OR WET LOCATIONS.
4. THIS TRACK IS IP20, INDOOR USE ONLY.
5. ALL ELECTRICAL CONNECTIONS SHOULD BE DONE BY A QUALIFIED ELECTRICIAN.

CONTENTS:



Surface mounted	1-2
Surface mounted with kits	3
Pendant mounted	4-5
Recessed mounted	6-8
Surface track connection	9
Trimless recessed flange track	10-11
Trimless recessed flange track connection	12

INSTALLATION INSTRUCTIONS

CAUTION:

1. BEFORE INSTALLING THE LIGHT FIXTURES, PLEASE READ THE INSTALLATION INSTRUCTIONS CAREFULLY.
2. DISCONNECT POWER AT CIRCUIT BREAKER BEFORE INSTALLATION OR SERVICING.
3. DO NOT INSTALL THE TRACK IN DAMP OR WET LOCATIONS.
4. THIS TRACK IS IP20, INDOOR USE ONLY.
5. ALL ELECTRICAL CONNECTIONS SHOULD BE DONE BY A QUALIFIED ELECTRICIAN.

SURFACE MOUNTED

INCLUDED HARDWARE

1 METER TRACK INCLUDES:

- 2 × SCREWS
- 2 × WALL PLUGS
- 1 × SCREWS
- 1 × ALLEN WRENCH
- 1 × WIRE CLIP

2 METER TRACK INCLUDES:

- 4 × SCREWS
- 4 × WALL PLUGS
- 2 × SCREWS
- 1 × ALLEN WRENCH
- 1 × WIRE CLIP

3 METER TRACK INCLUDES:

- 6 × SCREWS
- 6 × WALL PLUGS
- 3 × SCREWS
- 1 × ALLEN WRENCH
- 1 × WIRE CLIP

01 MARK CENTER LINE WHERE TRACK IS TO BE INSTALLED AND MAKE HOLES IN THE CEILING

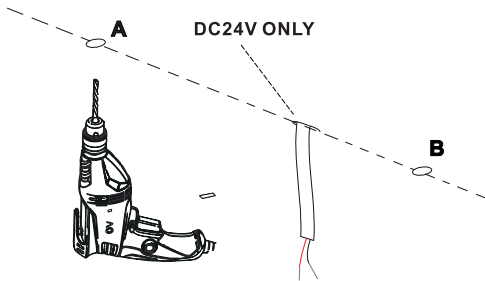

02 CONNECT 24 VOLT POWER FROM THE DRIVER TO THE TRACK, RED WIRE TO POSITIVE AND BLACK WIRE TO NEGATIVE. ATTACH THE WIRE RESTRAINT TO THE POWER CORD.

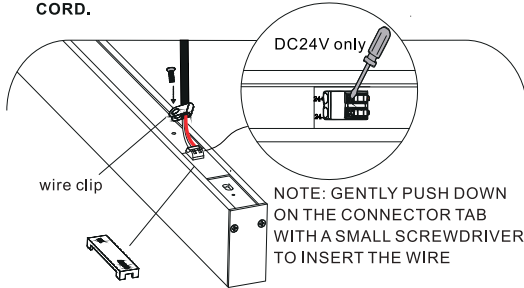

04 REMOVE MAGNET

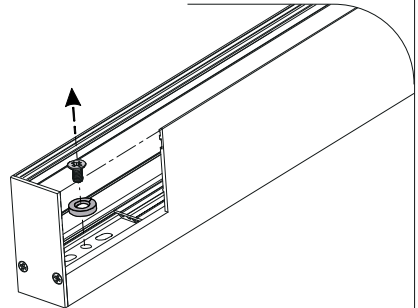

05 ATTACH ONE END OF TRACK TO CEILING

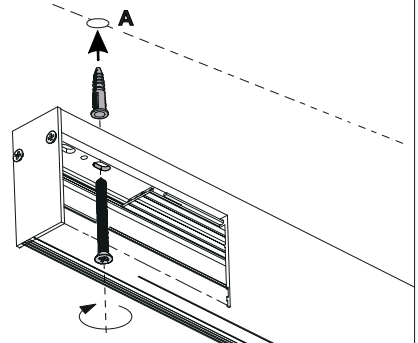

03 REMOVE DECORATIVE PLATE

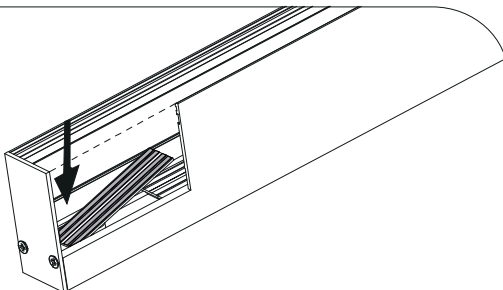

06 SLIDE PCB BOARDS TO END OF TRACK TO EXPOSE MOUNTING HOLE AT OPPOSITE END OF TRACK

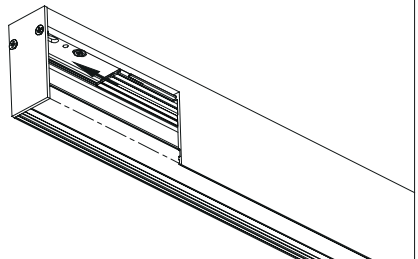

07 INSTALL DRYWALL ANCHOR AND SET SCREW TO HOLE B

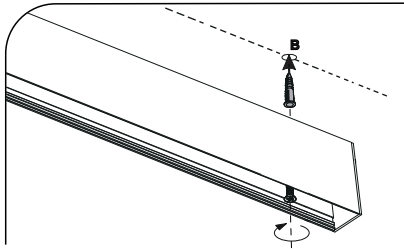

09 RE-INSTALL THE MAGNET AND DECORATIVE PLATE
(IF TWO TRACKS CONNECTION IS NEEDED, PLEASE SEE PAGE 9.)

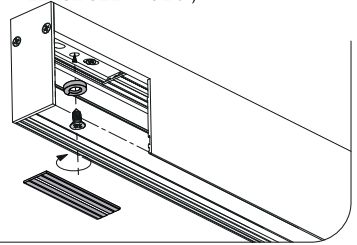

08 SLIDE PCB BOARDS TO END OF TRACK TO EXPOSE MOUNTING HOLE AT OPPOSITE END OF TRACK

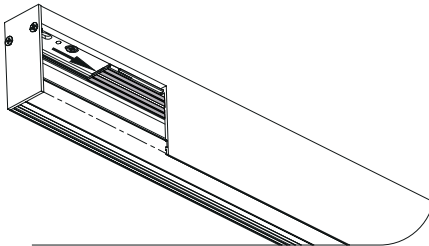

10 INSTALL THE FIXTURE

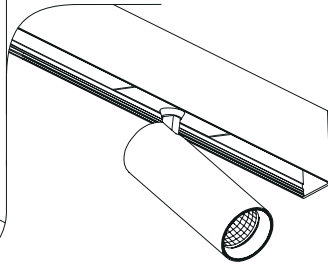

**SURFACE/PENDANT/RECESSED TRACK
INSTALLATION INSTRUCTIONS**

CAUTION:

1. BEFORE INSTALLING THE LIGHT FIXTURES, PLEASE READ THE INSTALLATION INSTRUCTIONS CAREFULLY.
2. DISCONNECT POWER AT CIRCUIT BREAKER BEFORE INSTALLATION OR SERVICING.
3. DO NOT INSTALL THE TRACK IN DAMP OR WET LOCATIONS.
4. THIS TRACK IS IP20, INDOOR USE ONLY.
5. ALL ELECTRICAL CONNECTIONS SHOULD BE DONE BY A QUALIFIED ELECTRICIAN.

Surface mounted with kits

ACCESSORIES REQUIRED

NEW SURFACE MOUNTED KIT

- 4 × NEW SURFACE KITS 
- 4 × SCREWS  4 × WALL PLUGS 
- 4 × WASHER 

01 MARK CENTER LINE WHERE TRACK IS TO BE INSTALLED

NOTE: 24-VOLT POWER COMING FROM CEILING MUST ALIGN WITH THE 24-VOLT INPUT CONNECTOR ON THE TRACK. INPUT CONNECTOR IS LOCATED 5 1/2 INCHES FROM END OF TRACK

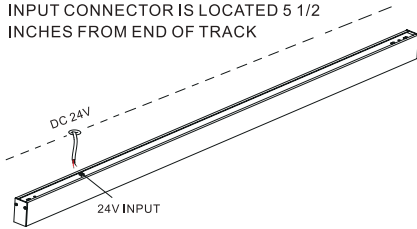

02 INSTALL SURFACE MOUNT KITS ALONG CENTER LINE BUT DO NOT OVER TIGHTEN. DO NOT INSTALL SURFACE MOUNT KITS WITHIN 8" OF THE ENDS OF THE TRACK AS THIS MAY INTERFERE WITH THE POWER ACCESS AREA AND WHERE TRACK JOINERS MAY BE USED.

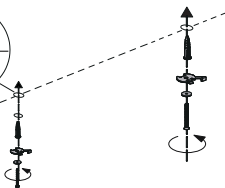
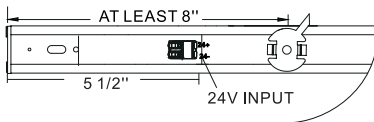

RECOMMENDED:
1 METER 2 KITS
2 METER 3 KITS
3 METER 4 KITS

03 CONNECT 24 VOLT POWER FROM THE DRIVER TO THE 24 VOLT ON THE TRACK, RED WIRE TO POSITIVE AND BLACK WIRE TO NEGATIVE. ATTACH THE WIRE RESTRAINT TO THE POWER CORD.

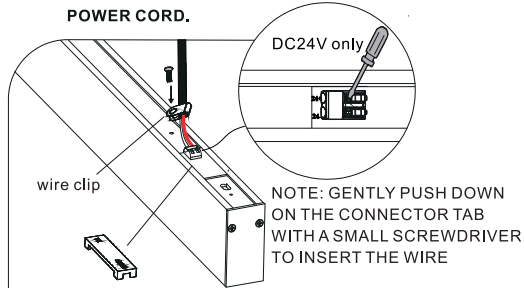

NOTE: GENTLY PUSH DOWN ON THE CONNECTOR TAB WITH A SMALL SCREWDRIVER TO INSERT THE WIRE

04 SECURE TRACK TO CEILING BY TURNING THE SURFACE MOUNT KITS LOCKING TRACK IN PLACE (KITS CAN BE USED SO THE TABS CAN BE ON EITHER SIDE OF THE TRACK EXAMPLE ALL ONE SIDE OR ALTERNATING FROM ONE SIDE TO THE OTHER)

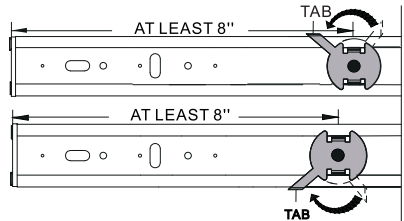

05 INSTALL THE FIXTURE

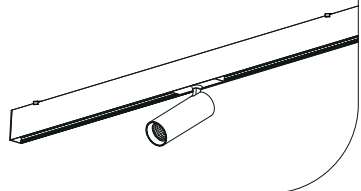

SURFACE/PENDANT/RECESSED TRACK INSTALLATION INSTRUCTIONS

CAUTION:

1. BEFORE INSTALLING THE LIGHT FIXTURES, PLEASE READ THE INSTALLATION INSTRUCTIONS CAREFULLY.
2. DISCONNECT POWER AT CIRCUIT BREAKER BEFORE INSTALLATION OR SERVICING.
3. DO NOT INSTALL THE TRACK IN DAMP OR WET LOCATIONS.
4. THIS TRACK IS IP20, INDOOR USE ONLY.
5. ALL ELECTRICAL CONNECTIONS SHOULD BE DONE BY A QUALIFIED ELECTRICIAN.

PENDANT MOUNTED

INCLUDED HARDWARE

- | | |
|-------------------------|-----------------|
| 1 × PENDANT POWER CABLE | 1 × CROSS BAR |
| 1 × ALLEN WRENCH | 2 × LONG SCREWS |
| 1 × WIRE CLIP | 2 × WALL PLUGS |
| 2 × SMALL SCREWS | 2 × M4*8 SCREW |
| 3 × Wire cap | |

PENDANT KIT-B WHICH INCLUDES:

- | | |
|----------------------|-----------------|
| 1 × SUSPENSION CABLE | 1 × CROSS BAR |
| 1 × ALLEN WRENCH | 2 × LONG SCREWS |
| 1 × WIRE CLIP | 2 × WALL PLUGS |
| 2 × SMALL SCREWS | 2 × M4*8 SCREW |

- RECOMMENDED CABLE SUPPORTS: 1 METER 1 PC
2 METER 1-2 PCS
3 METER 2-3PCS

01 MARK CENTER LINE WHERE TRACK IS TO BE INSTALLED

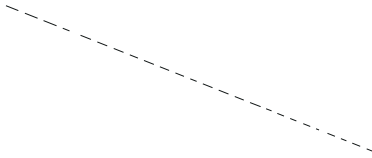

02 INSTALL CROSS BAR

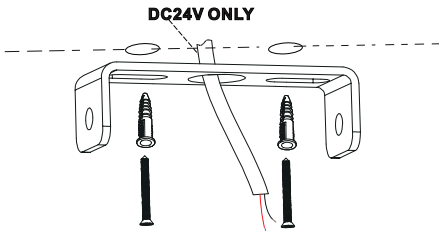

03 CONNECT THE POWER CABLE

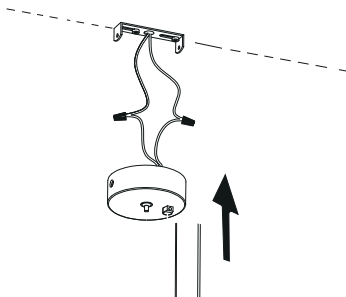

04 FIX THE CANOPY TO THE CROSS BAR

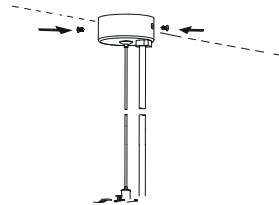

05 ATTACH ONE END OF TRACK TO CEILING

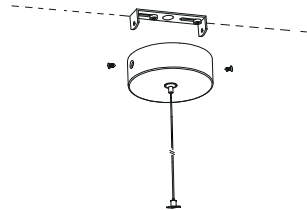

06 CONNECT 24 VOLT POWER FROM THE DRIVER TO THE 24 VOLT INPUT ON THE TRACK, RED WIRE TO POSITIVE AND BLACK WIRE TO NEGATIVE. ATTACH THE WIRE RESTRAINT TO THE POWER CORD.

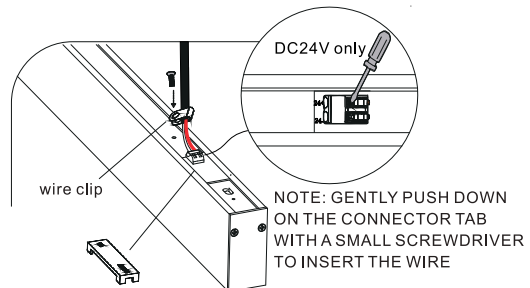

07 INSTALL SUSPENSION CABLES TO TRACK, SEE STEP 8 AND 9

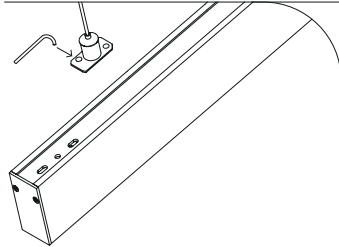

10 ADJUST SUSPENSION CABLE TO DESIRED HEIGHT BY PUSHING DOWN ON CABLE GRIPPER AND PULLING THE EXCESS CABLE. ONCE HEIGHT IS FINAL, CUT OFF EXCESS CABLE.

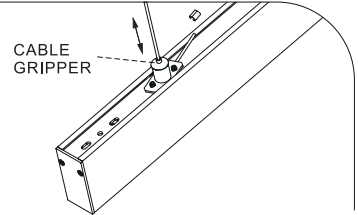

08 INSERT SET SCREWS BUT DO NOT TIGHTEN

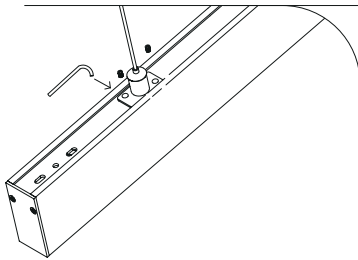

11 INSTALL THE WIRE CLIP

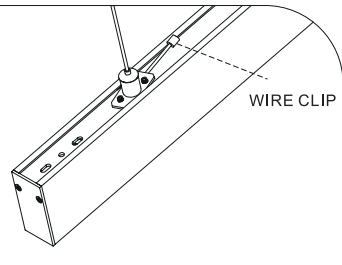

09 TURN CABLE CONNECTOR COUNTER-CLOCKWISE SO THE CORNERS OF THE CONNECTOR FIT UNDER THE TOP EDGES OF THE TRACK AND TIGHTEN SET SCREWS

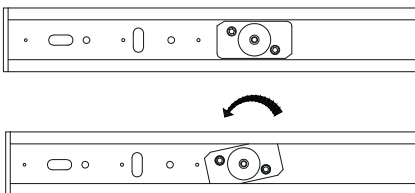

12 FINISH INSTALLATION OF THE TRACK

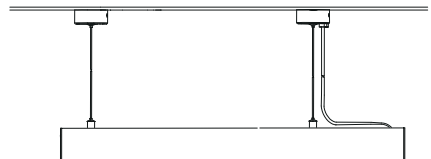

SURFACE/PENDANT/RECESSED TRACK INSTALLATION INSTRUCTIONS

CAUTION:

1. BEFORE INSTALLING THE LIGHT FIXTURES, PLEASE READ THE INSTALLATION INSTRUCTIONS CAREFULLY.
2. DISCONNECT POWER AT CIRCUIT BREAKER BEFORE INSTALLATION OR SERVICING.
3. DO NOT INSTALL THE TRACK IN DAMP OR WET LOCATIONS.
4. THIS TRACK IS IP20, INDOOR USE ONLY.
5. ALL ELECTRICAL CONNECTIONS SHOULD BE DONE BY A QUALIFIED ELECTRICIAN.

RECESSED MOUNTED

INCLUDED HARDWARE

RECESSED KITS

WHICH INCLUDES: 2 × RECESSED KITS



RECOMMENDED RECESSED KITS: 1 METER 2 PCS
2 METER 3 PCS
3 METER 4 PCS

POSITION

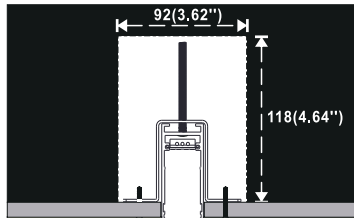

01 CUT HOLE FOR RECESSED MOUNT THE TRACK

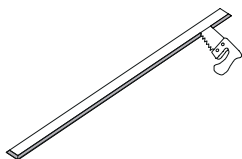

HOLE LENGTH SHOULD BE TOTAL LENGTH OF TRACK PLUS 2MM
HOLE WIDTH SHOULD BE WIDTH OF TRACK PLUS 2MM

02 REMOVE DECORATIVE PLATE

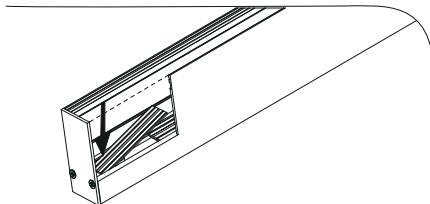

03 REMOVE MAGNET

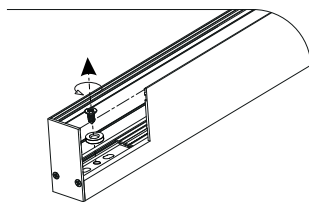

04 INSTALL RECESSED KIT 1

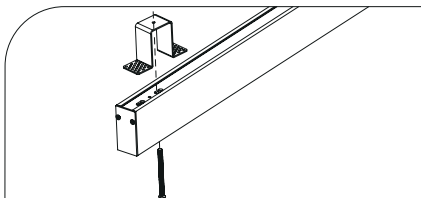

05 FIX THE RECESSED KIT BUT NOT TIGHT

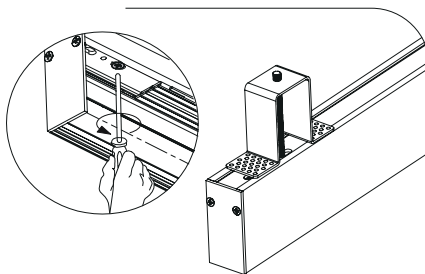

06 SLIDE PCB BOARDS TO END OF TRACK TO EXPOSE MOUNTING HOLE AT OPPOSITE END OF TRACK

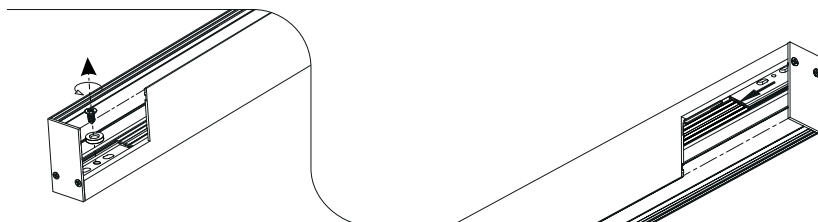

07 INSTALL RECESSED KIT 2

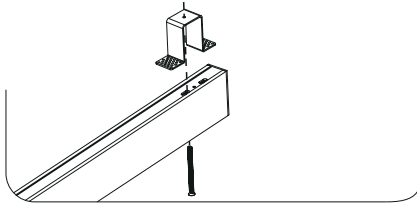

11

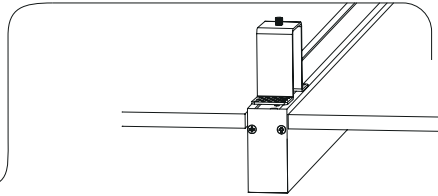

08 FIX THE RECESSED KIT BUT NOT TIGHT

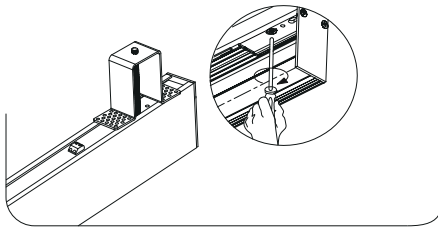

12 RELEASE THE RECESSED KIT AND TURN IT 90° TO DROP DOWN TO THE CEILING

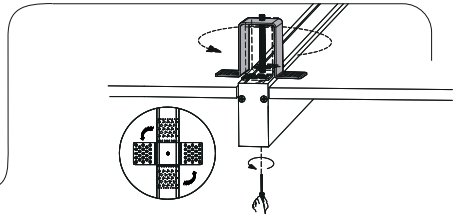

09 CONNECT 24 VOLT POWER FROM THE DRIVER TO THE 24 VOLT ON THE TRACK, RED WIRE TO POSITIVE AND BLACK WIRE TO NEGATIVE. ATTACH THE WIRE RESTRAINT TO THE POWER CORD.

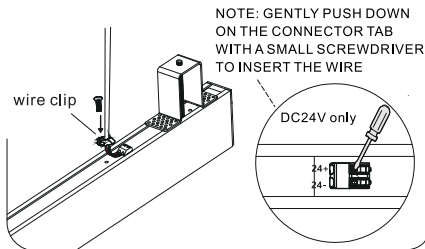

13 SCREW AND LIFT THE TRACK UP INTO THE CEILING

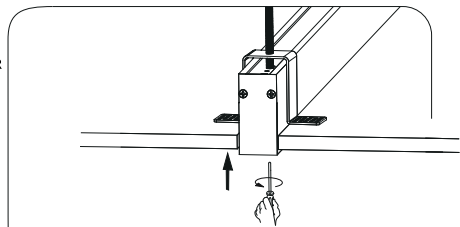

10 INSET TRACK PROFILE INTO THE CEILING

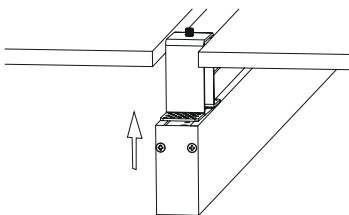

14 ATTACH TRACK WITH SCREWS

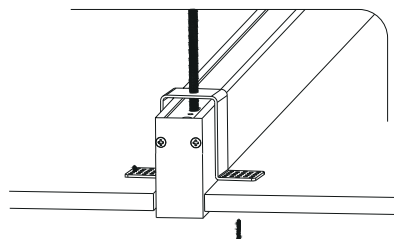

- 15 RE-INSTALL THE MAGNET AND DECORATIVE PLATE**
(IF TWO TRACKS CONNECTION IS NEEDED, PLEASE SEE PAGE 9.)

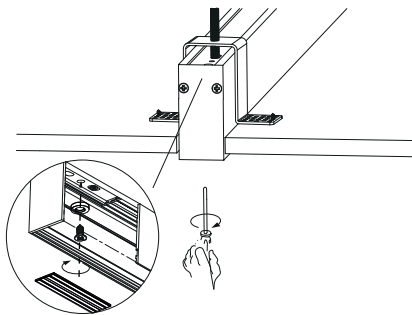

- 17 PLASTERING**

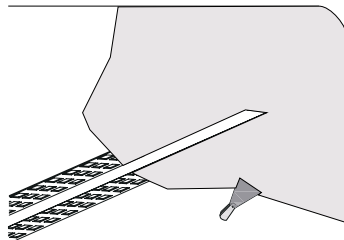

- Optional: INSTALL THE MSAR11 RECESSED TRACK COVER ONTO THE TRACK**

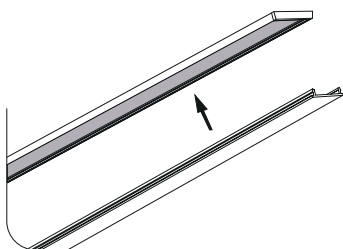

- 18 PAINTING**

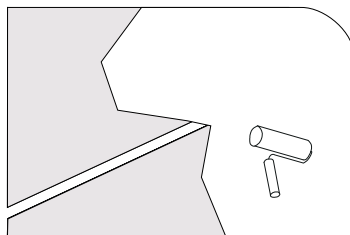

- 16 TAPING WITH FIBERGLASS TAPE**

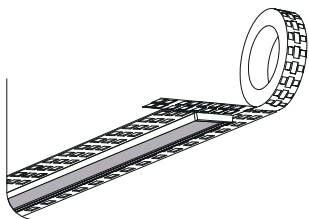

- 19 INSTALL THE FIXTURE**

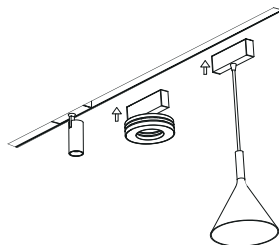

NOTE: CALCULATE THE WATTAGE OF ALL ELEMENTS BEING USED TO MAKE SURE MAXIMUM WATTAGE OF REMOTE DRIVER IS NOT BEING EXCEEDED.

**SURFACE/PENDANT/RECESSED TRACK
INSTALLATION INSTRUCTIONS**

CAUTION:

1. BEFORE INSTALLING THE LIGHT FIXTURES, PLEASE READ THE INSTALLATION INSTRUCTIONS CAREFULLY.
2. DISCONNECT POWER AT CIRCUIT BREAKER BEFORE INSTALLATION OR SERVICING.
3. DO NOT INSTALL THE TRACK IN DAMP OR WET LOCATIONS.
4. THIS TRACK IS IP20, INDOOR USE ONLY.
5. ALL ELECTRICAL CONNECTIONS SHOULD BE DONE BY A QUALIFIED ELECTRICIAN.

**SURFACE/PENDANT/RECESSED
TRACK CONNECTION**

INCLUDED HARDWARE

65MM POWER PLATE

WHICH INCLUDES: 1 × POWER PLATE

2 × PIN3

TRACK CONNECTOR-S

WHICH INCLUDES: 1 × TRACK CONNECTOR



01 REMOVE DECORATIVE PLATE

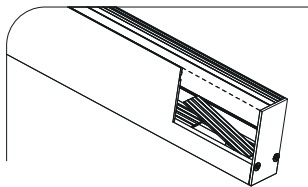

02 REMOVE MAGNET

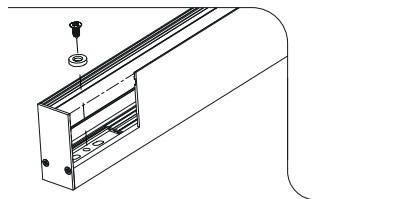

03 REMOVE DECORATIVE PLATE

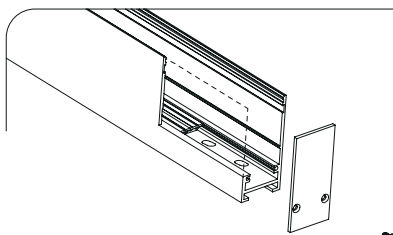

04 INSERT THE 65MM POWER PLATE

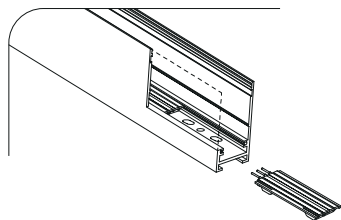

- 05 INSTALL THE PIN SET (b) INTO THE PIN CONNECTOR HOLES (c) ON THE TRACK. SLIDE THE TRACK CONNECTOR-S (a) INTO THE SLOT ON THE BACK OF THE TRACK APPROXIMATELY HALFWAY AND SECURE TO TRACK WITH TWO SET SCREWS.**

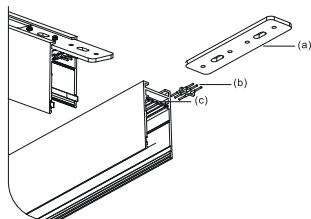

- 06 SLIDE SECOND TRACK ONTO THE TRACK CONNECTOR WHILE CAREFULLY LINING UP THE PIN SET ON THE FIRST TRACK WITH THE PIN SET HOLES ON THE SECOND TRACK.**

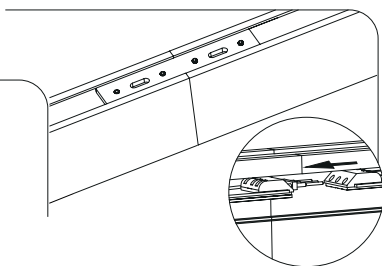

07 COMPLETED TRACK CONNECTION

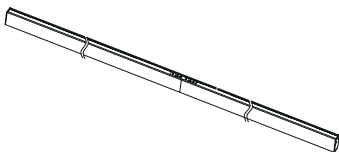

TRIMLESS RECESSED FLANGE TRACK INSTALLATION INSTRUCTIONS

NOTE:

1. TRACK SECTIONS SHOULD BE JOINED TOGETHER ON THE FLOOR BEFORE INSTALLING INTO THE CEILING.
2. WHEN INSTALLING LONGER TRACK RUNS UTILIZING MULTIPLE 200 WATT SECTIONS, YOU MUST ENSURE THE ELECTRICAL CONNECTION BETWEEN EACH SECTION IS TERMINATED. A NEW CONNECTION FROM THE DRIVER SHOULD BE MADE AT THE START OF EACH ADDITIONAL 200 WATT SECTION WITHOUT THE USE OF 3-PIN CONNECTORS OR RECESSED CABLE CONNECTORS.

Trimless recessed flange track

INCLUDED HARDWARE

1 METER TRACK INCLUDES:

- 4 × SCREWS
- 4 × WALL PLUGS
- 1 × ALLEN WRENCH
- 1 × MALE POWER CABLE

2 METER TRACK INCLUDES:

- 6 × SCREWS
- 6 × WALL PLUGS
- 1 × ALLEN WRENCH
- 1 × MALE POWER CABLE

3 METER TRACK INCLUDES:

- 8 × SCREWS
- 8 × WALL PLUGS
- 1 × ALLEN WRENCH
- 1 × MALE POWER CABLE

INSTALLATION

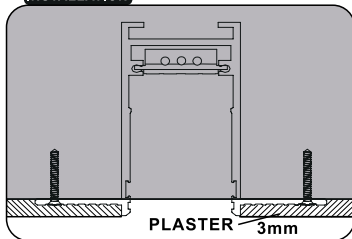

END CAPS

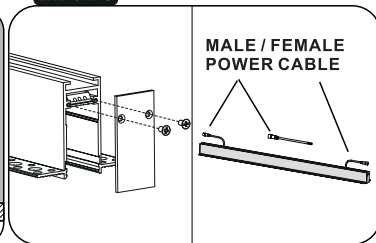

INSTALLATION POSITION

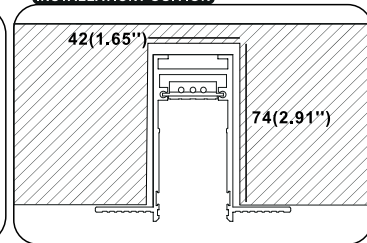

01 REMOVE TRACK AND ACCESSORIES FROM BOX

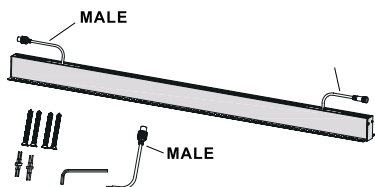

02 CONNECT THE PROVIDED MALE POWER CABLE TO THE FEMALE TRACK CABLE BY LINING UP THE ARROWS ON THE CABLE CONNECTORS AND PUSH TOGETHER. SECURE WITH THE CABLE NUT.

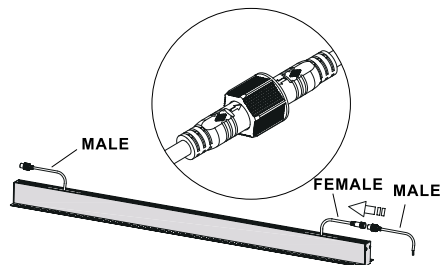

03 CUT HOLE FOR RECESSED TRACK

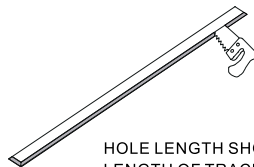

HOLE LENGTH SHOULD BE TOTAL LENGTH OF TRACK PLUS 1/4"
HOLE WIDTH SHOULD BE 1 5/16"
HOLE DEPTH SHOULD BE MIN. 3"

04 CONNECT POWER FROM REMOTE DRIVER (a) TO PROVIDED POWER CABLE (b), CONNECT MALE POWER CABLE (b) TO TRACK POWER CABLE (c), INSTALL TRACK

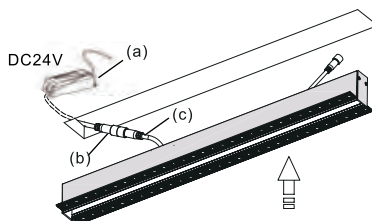

05 ATTACH TRACK WITH SCREWS

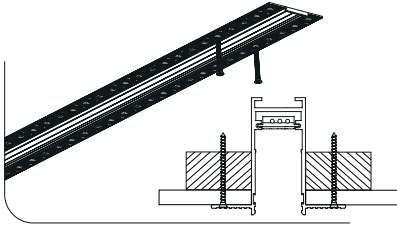

08 PAINTING

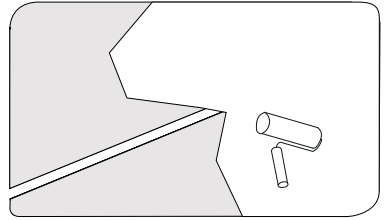

Optional INSTALL THE RECESSED TRACK COVER ONTO THE TRACK

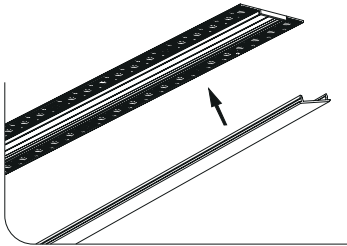

Optional REMOVE THE MSAR11 RECESSED TRACK COVER FROM TRACK

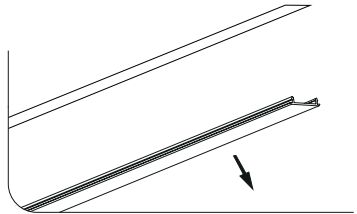

06 TAPING WITH FIBERGLASS TAPE

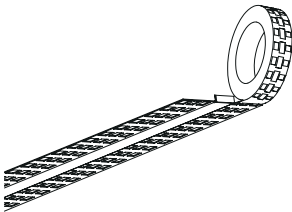

09 INSTALL THE FIXTURE

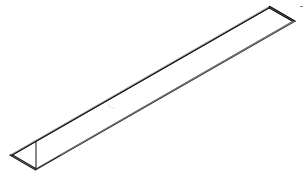

07 PLASTERING

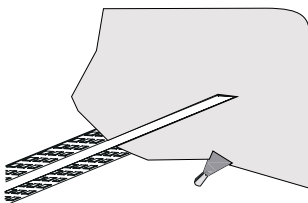

10 INSTALL THE FIXTURE

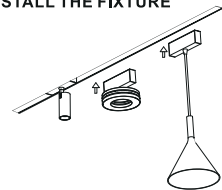

NOTE: CALCULATE THE WATTAGE OF ALL ELEMENTS BEING USED TO MAKE SURE MAXIMUM WATTAGE OF REMOTE DRIVER IS NOT BEING EXCEEDED.

TRIMLESS RECESSED FLANGE TRACK INSTALLATION INSTRUCTIONS

CAUTION:

1. BEFORE INSTALLING THE LIGHT FIXTURES, PLEASE READ THE INSTALLATION INSTRUCTIONS CAREFULLY.
2. DISCONNECT POWER AT CIRCUIT BREAKER BEFORE INSTALLATION OR SERVICING.
3. DO NOT INSTALL THE TRACK IN DAMP OR WET LOCATIONS.
4. THIS TRACK IS IP20, INDOOR USE ONLY.
5. ALL ELECTRICAL CONNECTIONS SHOULD BE DONE BY A QUALIFIED ELECTRICIAN.

TRIMLESS RECESSED FLANGE TRACK CONNECTION

01 REMOVE END CAPS FROM TRACK WHERE TRACK WILL BE JOINED



NOTE : WHEN JOINING A TRACK, BE SURE TO CHECK THAT YOU ARE JOINING THE CORRECT END OF THE ADDED TRACK IN ORDER TO MATCH THE MALE/FEMALE POWER CABLES.

02 SLIDE TRACK CONNECTOR (a) HALFWAY INTO THE SLOT ON THE BACK OF THE TRACK AND SECURE WITH PROVIDED SETSCREWS.

(OPTIONAL - INSERT PIN CONNECTORS (b) INTO THE PIN CONNECTOR HOLES (c). THIS STEP IS NECESSARY IF YOU ARE UNABLE TO USE THE CABLE CONNECTORS. OTHERWISE SKIP THE PIN CONNECTION STEP.)

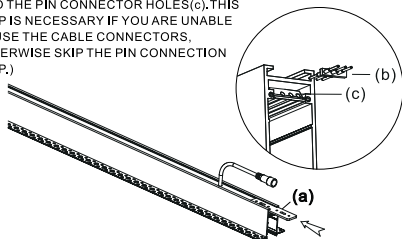

03 SLIDE THE NEXT TRACK ONTO THE TRACK CONNECTOR (a). SECURE REMAINING SET SCREWS ON TRACK CONNECTOR.

NOTE: MAY HAVE TO TAP END OF TRACK WITH A RUBBER Mallet TO ENSURE TIGHT FIT.

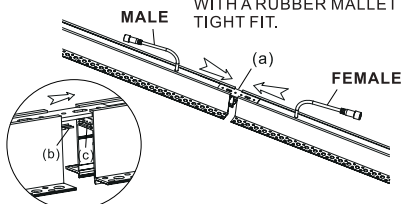

(IF USING PIN CONNECTION INSTEAD OF CABLE CONNECTION, CAREFULLY LINE UP THE PINS (b) WITH THE PIN CONNECTOR HOLES (c) ON THE NEXT TRACK.)

INCLUDED HARDWARE

TRACK CONNECTOR-S

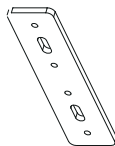

ATTENTION

WHEN JOINING TRACKS OR ACCESSORIES UTILIZING PIN CONNECTORS, MAKE SURE PINS ARE HORIZONTAL AND LINE UP WITH PIN CONNECTOR HOLES. YOU MAY NEED TO GENTLY PUSH UP OR DOWN ON THE PINS SO THEY LINE UP CORRECTLY. FAILING TO DO THIS MAY RESULT IN PINS MISSING THE PIN CONNECTOR HOLES AND LOSS OF THE 24 VOLT CONNECTION.

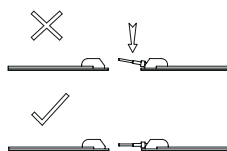

04 CONNECT MALE / FEMALE CABLE CONNECTORS

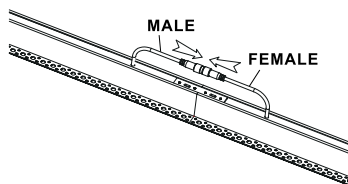

05 COMPLETED TRACK CONNECTION

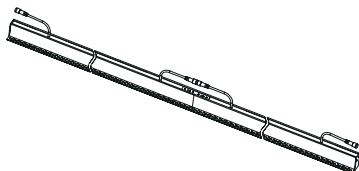

NOTE:

COMPLETE THESE STEPS FOR EACH ADDITIONAL TRACK. AFTER EACH TRACK CONNECTION A CONTINUITY TEST SHOULD BE DONE TO ENSURE PROPER ELECTRICAL CONNECTIONS WERE MADE.

ARCHITECTURAL LIGHTING

less is more
more than linear
human centric lighting
linear style
intelligent control
extremely functional
variety of mounting
invisible lamp
visual comfort
magnetic fixing
natural CCT alternative
full spectrum